



UNIS BUSINESS

PRODUCT CATALOGUE ÜRÜN KATALOĐU

www.unisbusiness.com





UNIS BUSINESS

YOUR GLOBAL SOLUTION PARTNER

ŞİRKET PROFİLİ / COMPANY PROFILE

Genç bir firma olan ÜNİS LTD ŞTİ sektörel deneyimleri yeterli bir yönetim ve çalışma iş ortaklarına sahiptir. Çağın gereksinimlerine, müşteri ihtiyaçlarına en iyi şekilde cevap verebilecek güçte olan ÜNİS LTD ŞTİ sektörel yenilikleri ve teknolojik gelişmeleri yakından takip etmektedir. Ticaret tecrübemizi müşterilerimizle paylaşmak, kendilerinin istifadesine sunmak, çok farklı ve zorlu kuralların hakim olduğu bu piyasa şartlarını en hafife indirmek amacıyla yola çıktık. Güçlü olduğumuz sektörler özellikle mobilya ve aksesuar, iç ve dış dekorasyon, inşaat malzemeleri, otomotiv yedek parçalarıdır.

Şirket merkezi Gebze / Kocaeli /

Türkiye'dedir. UNIS BUSINESS, sürekli olarak kendini geliştirmekte ve yenilikçi çözümler sunmak için çalışmaktadır. Türkiye'den tüm dünyaya geniş bir yelpazede iş ağını geliştirmektedir. UNIS BUSINESS, ürünlerinizi Türkiye pazarına dağıtmak ve satmak veya Türk üreticilerin ürünlerini ithal etmek için Türkiye'ye giriş kapınızdır. Riskleri ve maliyetleri azaltın ve haklarınızı korumak ve işinizi geliştirmek için tecrübemizi kullanın.

ÜNİS LTD CO sector experience is a young company that has an adequate management and operations partner. The age requirements, customer requirements, which are able to respond in the best way ÜNİS LTD CO sectoral innovations and technological developments are followed closely. Our trading experience to share with our customers, to provide the benefit of themselves, which is dominated by very different rules and challenging market conditions that we set out to download the most light. We have a strong industry, especially furniture and accessories, interior and exterior decoration, construction materials, automotive spare parts.

Company center is located in Gebze / Kocaeli / TURKEY.

UNIS BUSINESS is constantly developing itself and working to provide innovative solutions. We are developing a wide range of businesses network covering from Turkey to all over the world. UNIS BUSINESS is your gateway to access Turkish market to distribute and sale your products or import Turkish manufacturers products. Reduce the risks and costs and use our experience to keep your rights and expend your business.



ÜNİS MOBİLYA İÇ ve DIŞ TİCARET LTD. ŞTİ.
UNIS FURNITURE DOMESTIC AND FOREIGN TRADE LTD. CO.

Sliding Door Systems	4-24
Led Hanger & Trouser Rack	19
Wardrobe	20
Aluminium Profiles	22-24
Aluminium Handle Systems	25-27
Aluminium Frame Cover System	28-29
Kitchen Systems	30-37
PVC Plinth	31
Plinth Legs and Clips	32
PVC Skirtings	33
Kitchen Cabinet Products	34-37
Under Counter Profiles-Gola	36
Furniture Fasteners	38-51
ALM Grilles Led Profiles& Wooden Door Gaskets	50-51
Unis Business	52
Conditions	53



SLIDING DOOR SYSTEMS



UNIS
BUSINESS

UNS-DM 9630 Sürme Kapak Mekanizması
UNS-DM 9630 Sliding Door Mechanism

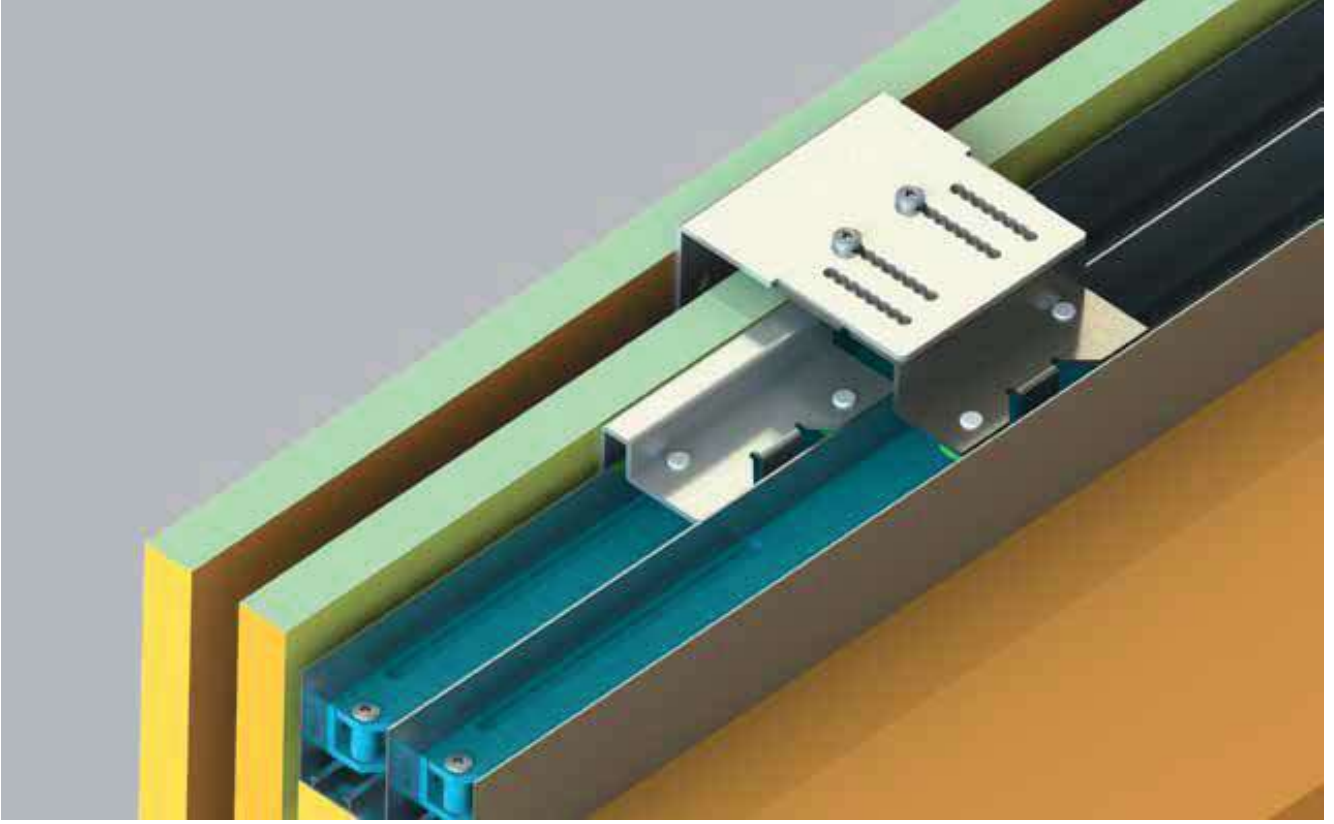

UNS-DM 9630 Dış Üst Kılavuz
UNS-DM 9630 Top External Guide



UNS-DM 9630 İç Üst Kılavuz
UNS-DM 9630 Top Internal Guide



UNS 100 Sürme Kapak Mekanizması
UNS 100 Sliding Door Mechanism



UNS 90 Sürme Kapak Mekanizması
UNS 90 Sliding Door Mechanism



UNS-OB 9202 Yağlı Fren
UNS-OB 9202 Oil Brake

UNS-DM 9630 Sürme Kapak Mekanizması
UNS-DM 9630 Sliding Door Mechanism

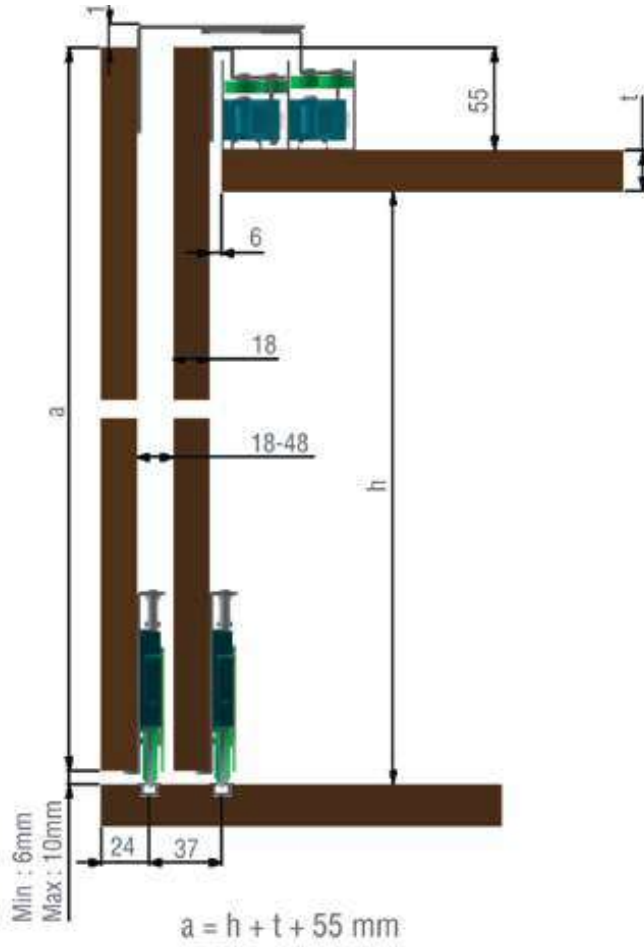

Uns-Dm 9630 Frenli Sürgü Kapak mekanizması 80 kg. taşıma kapasitelidir. Alt ve üstte polyamid kaplı rulmanlı tekerlekle çalışır. Görünüm ve estetik en üst seviyede tasarlanmıştır. Seçilecek sisteme uygun frenler ve ayarlı alt makaralar ürün tablolarında belirtilmiştir.

Uns-Dm 9630 is a mechanism with soft closes and it can carry till 80 kg. Bottom and Top rollers are covered with polyamide. Suitable rollers and soft close mechanism for UNS-DM 9630 are in the following mechanism charts.

UNS-DM 9630 Alüminyum Alt ve Üst Rayları
UNS-DM 9630 Aluminium Top and Bottom Rails

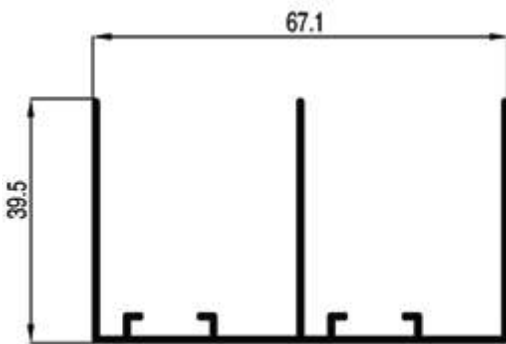

92645

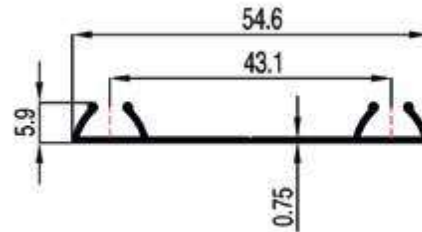

92009

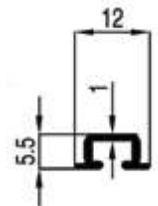

91039

UNS-DM 9640 Sürme Kapak Mekanizması
UNS-DM 9640 Sliding Door Mechanism

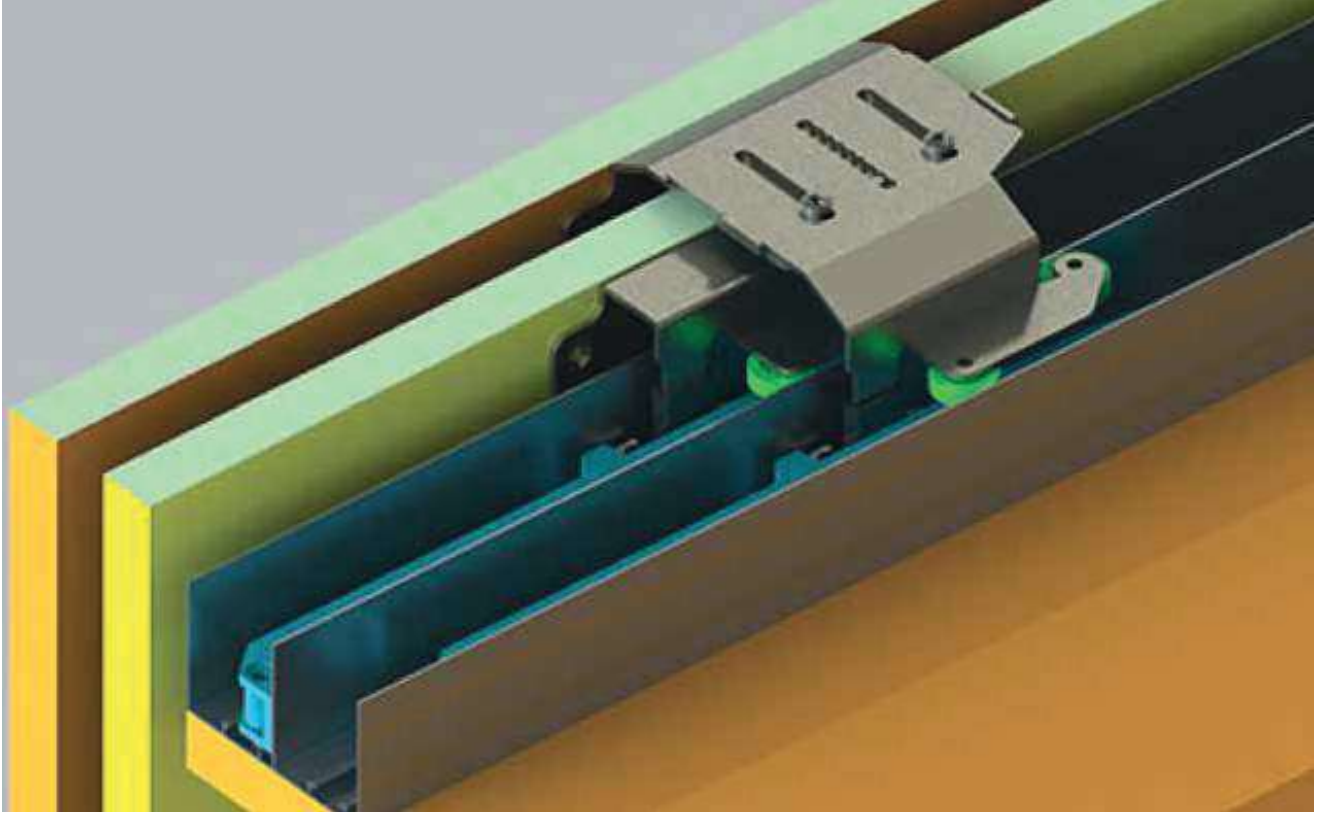

UNS-DM 9640 Dış Üst Kılavuz
UNS-DM 9640 Top External Guide



UNS-DM 9640 İç Üst Kılavuz
UNS-DM 9640 Top Internal Guide



UNS 100 Sürme Kapak Mekanizması
UNS 100 Sliding Door Mechanism



UNS 90 Sürme Kapak Mekanizması
UNS 90 Sliding Door Mechanism



UNS-OB 9202 Yağlı Fren
UNS-OB 9202 Oil Brake

UNS-DM 9640 Sürme Kapak Mekanizması
UNS-DM 9640 Sliding Door Mechanism

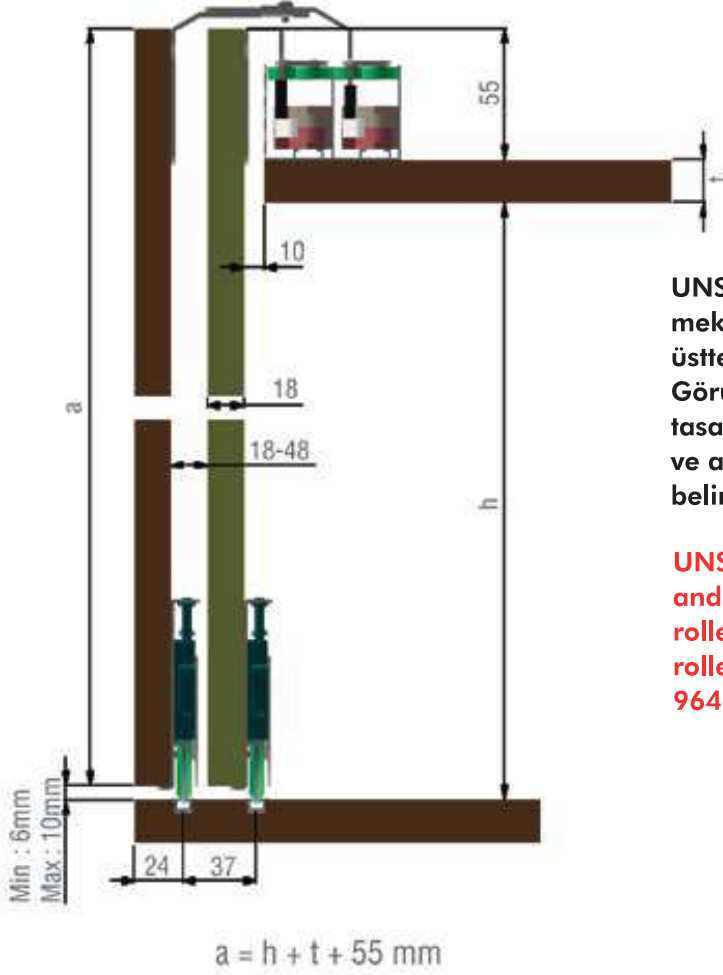

UNS-DM 9640 Frenli Sürgü Kapak mekanizması 80 kg. taşıma kapasitelidir. Alt ve üstte polyamid kaplı rulmanlı tekerlekle çalışır. Görünüm ve estetik en üst seviyede tasarlanmıştır. Seçilecek sisteme uygun frenler ve ayarlı alt makaralar ürün tablolarında belirtilmiştir.

UNS-DM 9640 is a mechanism with soft closes and it can carry till 80 kg. Bottom and Top rollers are covered with polyamide. Suitable rollers and soft close mechanism for UNS-DM 9640 are in the following mechanism charts.

UNS-DM 9640 Alüminyum Alt ve Üst Rayları
UNS-DM 9640 Aluminium Top and Bottom Rails

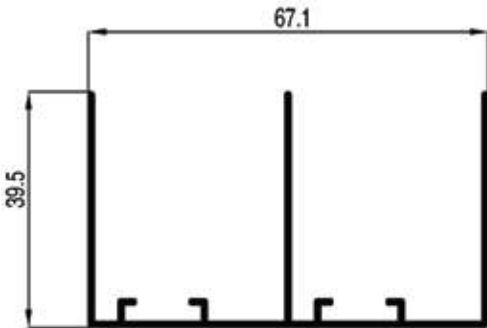

92645

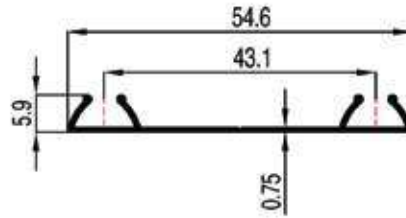

92009

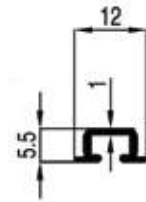

91039

UNS-DM 9057 Sürme Kapak Mekanizması
UNS-DM 9057 Sliding Door Mechanism



UNS-DM 9057 iç Üst Kılavuz Sol
UNS-DM 9057 Top Internal Guide Left



UNS-DM 9057 iç Üst Kılavuz Sağ
UNS-DM 9057 Top Internal Guide Right



UNS 90 Sürme Kapak Mekanizması
UNS 90 Sliding Door Mechanism



UNS-OB 9057 Yağlı Fren
UNS-OB 9057 Oil Brake

UNS-DM 9057 Sürme Kapak Mekanizması
UNS-DM 9057 Sliding Door Mechanism



UNS-DM 9057 Ayarlı ve ray içi yavaşlatıcı sürgü kapak mekanizması 37 mm üst raya göre hazırlanmış ve ray içi yavaşlatıcı sürgü kapaklar için özel olarak hazırlanmıştır. Alt pom kaplı rulmanlı tekerlekle çalışır, üst teker tasarım özelliklerinden dolayı kapak sallantı ve ses yapmamaktadır.

UNS-DM 9057 Sliding Door Mechanism is designed for 37 mm top rail . It can be used with soft close mechanism . It works with bottom rollers which has bearings inside. That makes mechanism work smoothly and sliently

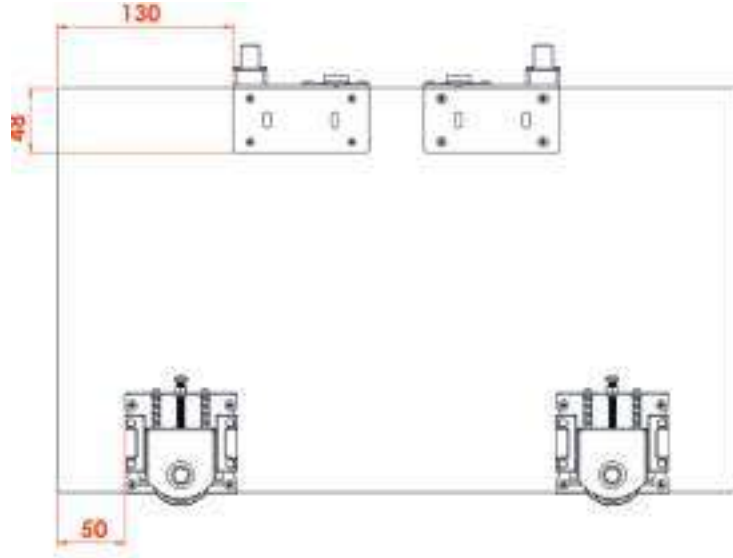

UNS-DM 9057 Alüminyum Alt ve Üst Rayları
UNS-DM 9057 Aluminium Top and Bottom Rails

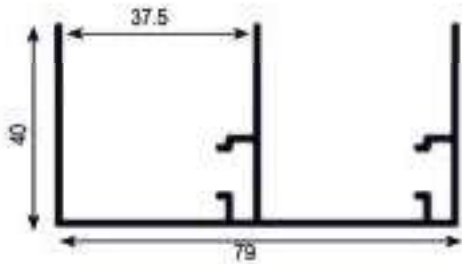

92057

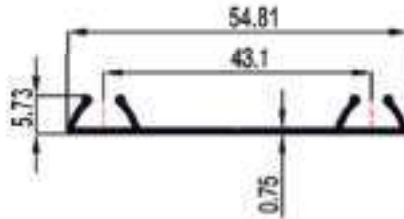

92009

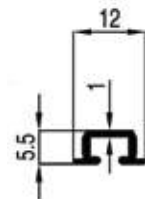

91039

UNS-DM 9037 Sürme Kapak Mekanizması
UNS-DM 9037 Sliding Door Mechanism

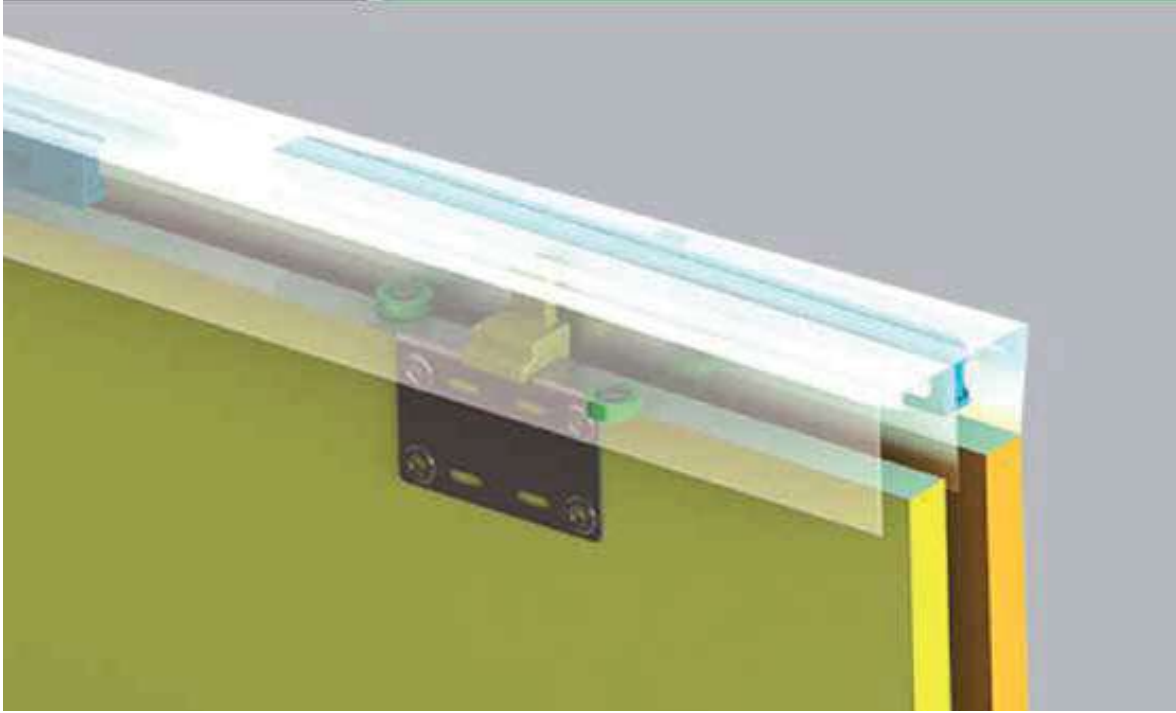

UNS-DM 9037 Üst Kılavuz
UNS-DM 9037 Top Guide



UNS-AB 9300 Havalı Fren
UNS-AB 9300 Air Brake



UNS-OB 9202 Yağlı Fren
UNS-OB 9202 Oil Brake



UNS 80 EKO Panel Kapak Mekanizması
UNS 80 ECO Sliding Door Mechanism



UNS 90 Sürme Kapak Mekanizması
UNS 90 Sliding Door Mechanism



UNS 100 Sürme Kapak Mekanizması
UNS 100 Sliding Door Mechanism

UNS-DM 9037 Sürme Kapak Mekanizması
UNS-DM 9037 Sliding Door Mechanism

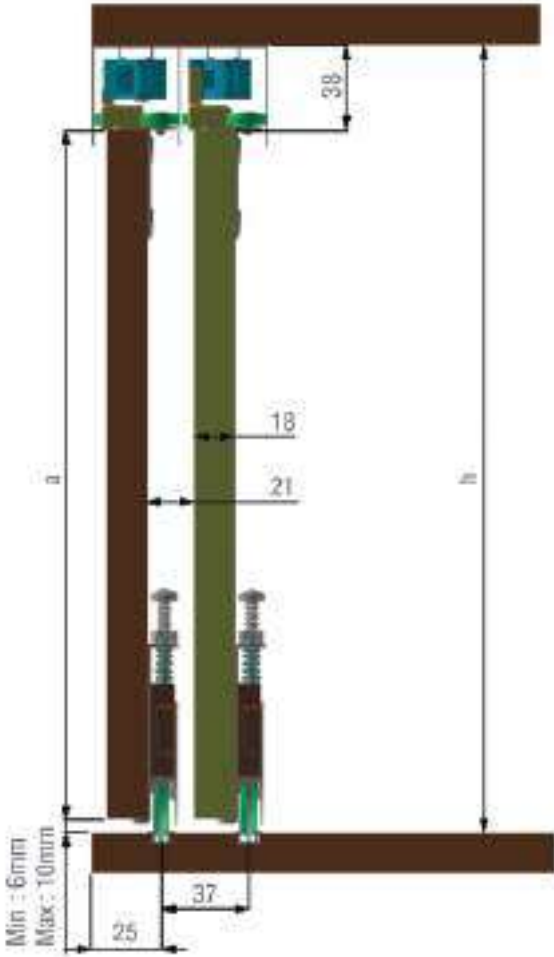

UNS-DM 9037 Ayarlı ve ray içi yavaşlatıcı sürgü kapak mekanizması 37 mm üst raya göre hazırlanmış ve ray içi yavaşlatıcılı sürgü kapaklar için özel olarak hazırlanmıştır. Alt pom kaplı rulmanlı tekerlekle çalışır, üst teker tasarım özelliklerinden dolayı kapak sallantı ve ses yapmamaktadır

UNS-DM 9037 Sliding Door Mechanism is designed for 37 mm top rail. It can be used with soft close mechanism. It works with bottom rollers which has bearings inside. That makes mechanism work smoothly and silently.

UNS-DM 9037 Alüminyum Alt ve Üst Rayları
UNS-DM 9037 Aluminium Top and Bottom Rails

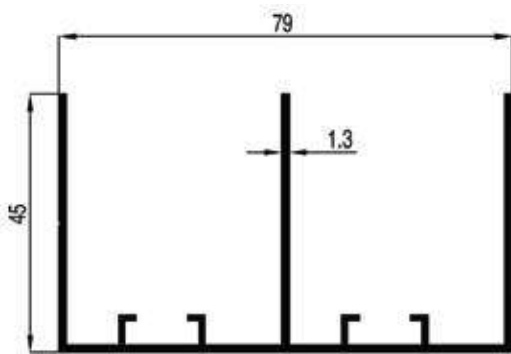

91217

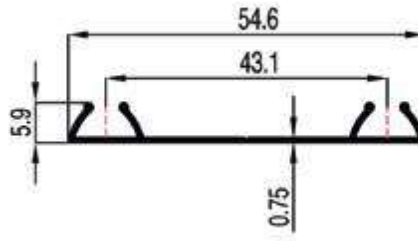

92009

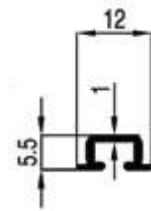

91039

UNS-DM 9034 Sürme Kapak Mekanizması
UNS-DM 9034 Sliding Door Mechanism

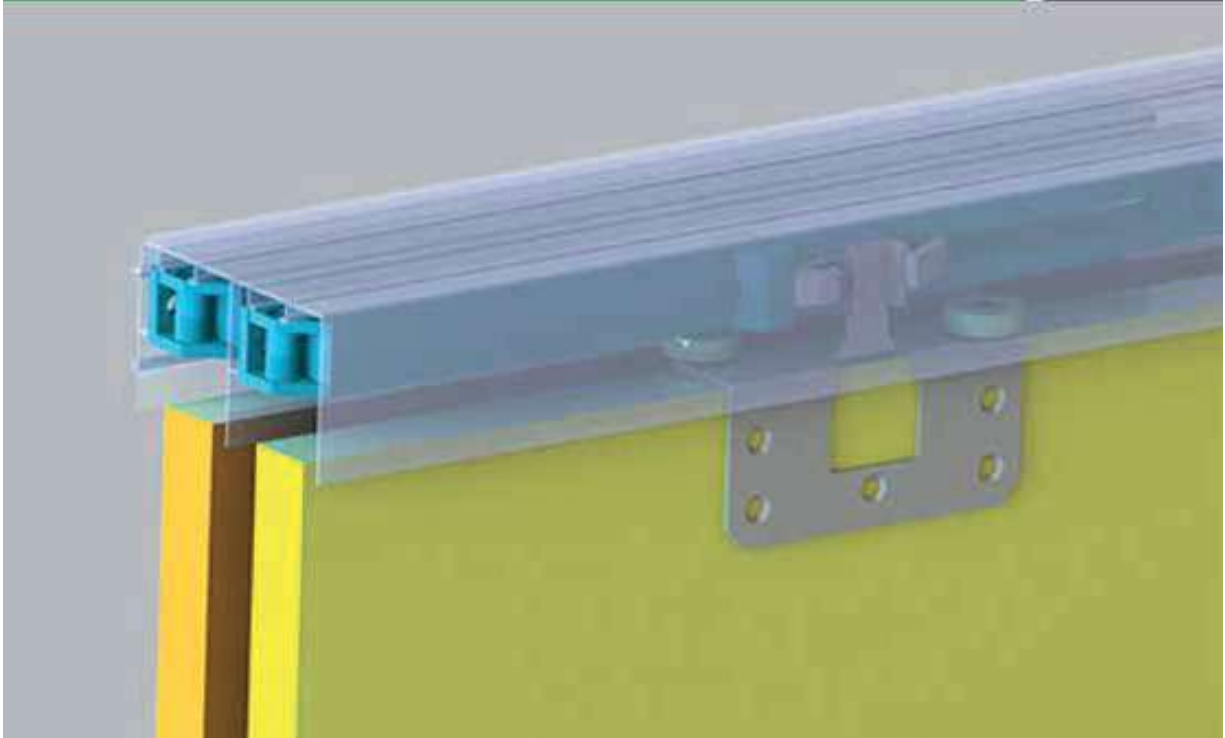

UNS-DM 9034 Üst Kılavuz
UNS-DM 9034 Top Guide



UNS-AB 9300 Havalı Fren
UNS-AB 9300 Air Brake



UNS-OB 9202 Yağlı Fren
UNS-OB 9202 Oil Brake



UNS 80 EKO Panel Kapak Mekanizması
UNS 80 ECO Sliding Door Mechanism



UNS 90 Sürme Kapak Mekanizması
UNS 90 Sliding Door Mechanism



UNS 100 Sürme Kapak Mekanizması
UNS 100 Sliding Door Mechanism

UNS-DM 9034 Sürme Kapak Mekanizması
UNS-DM 9034 Sliding Door Mechanism

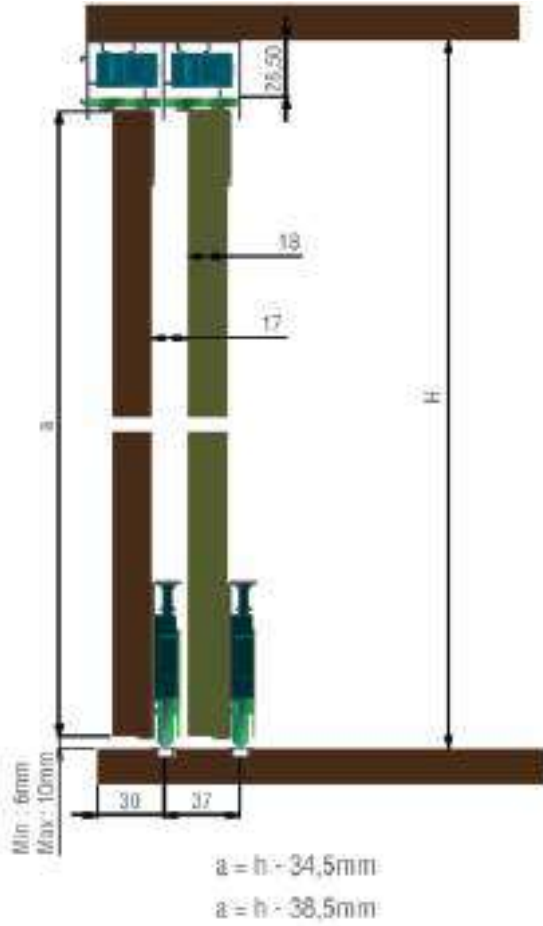

UNS-DM 9034 Ayarlı ve ray içi yavaşlatıcı sürgü kapak mekanizması 34 mm üst raya göre hazırlanmış ve ray içi yavaşlatıcılı sürgü kapaklar için özel olarak hazırlanmıştır. Alt pom kaplı rulmanlı tekerlekle çalışır, üst teker tasarım özelliklerinden dolayı kapak sallantı ve ses yapmamaktadır.

UNS-DM 9034 Sliding Door Mechanism is designed for 34 mm top rail. It can be used with soft close mechanism. It works with bottom rollers which has bearings inside. That makes mechanism work smoothly and silently.

UNS-DM 9034 Alüminyum Alt ve Üst Rayları
UNS-DM 9034 Aluminium Top and Bottom Rails

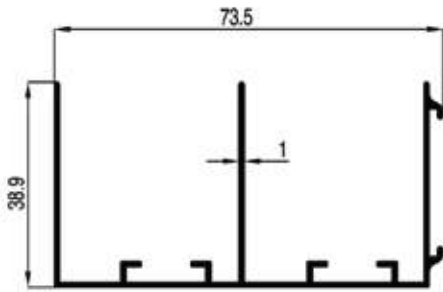

93017

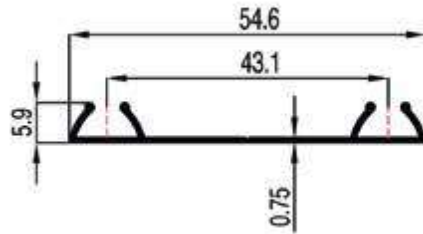

92009

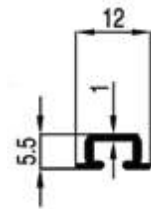

91039

UNS-DM 9040 Sürme Kapak Mekanizması
UNS-DM 9040 Sliding Door Mechanism

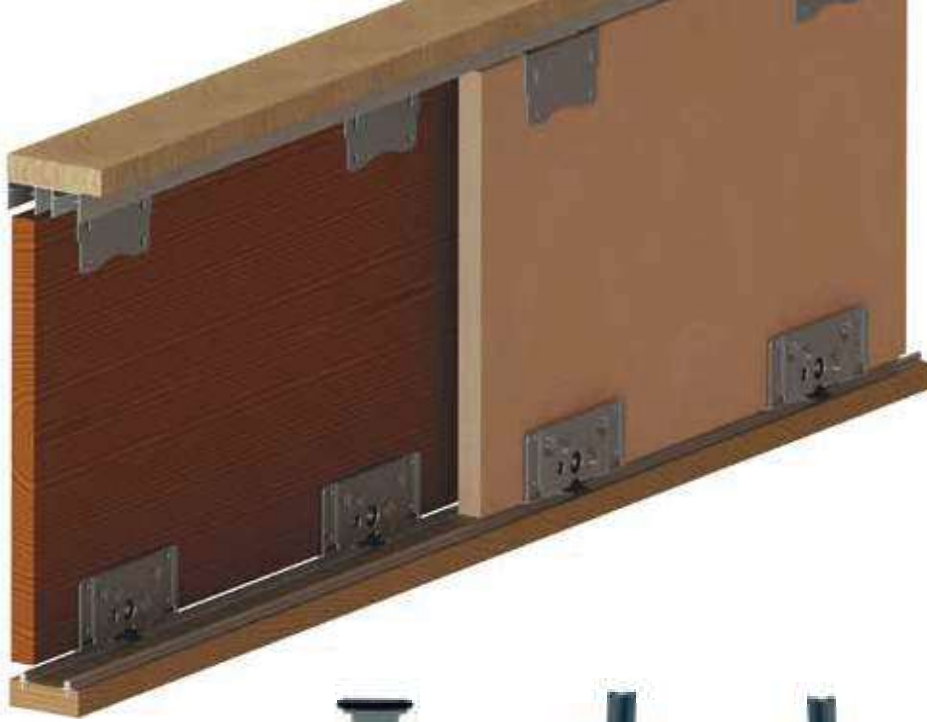

UNS 100 Sürme Kapak Mekanizması
UNS 100 Sliding Door Mechanism



UNS-DM 9040 Üst Kılavuz Sağ
UNS-DM 9040 Top Guide Right



UNS-DM 9040 Üst Kılavuz Sol
UNS-DM 9040 Top Guide Left



UNS-DM 9040 Stoper
UNS-DM 9040 Stopper



UNS-DM 9040 Klavuz
UNS-DM 9040 Guide



UNS-OB 9101 Yağlı Fren
UNS-OB 9101 Oil Brake

UNS-DM 9040 Alüminyum Alt ve Üst Rayları
UNS-DM 9040 Aluminium Top and Bottom Rails

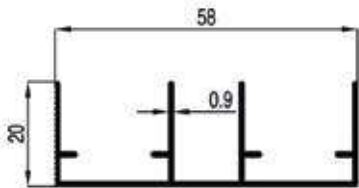

92639

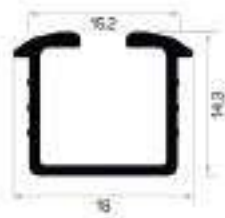

91017

UNS-DM 9041 Sürme Kapak Mekanizması
UNS-DM 9041 Sliding Door Mechanism

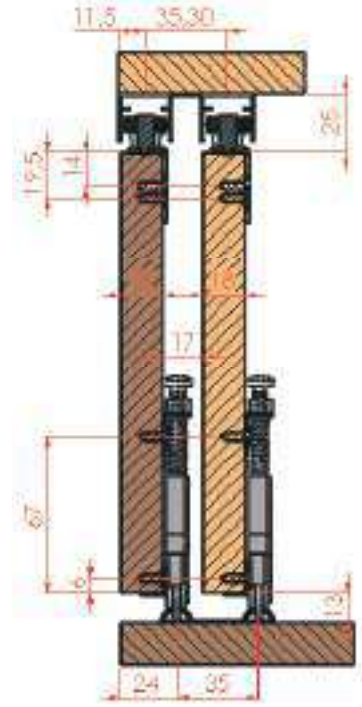
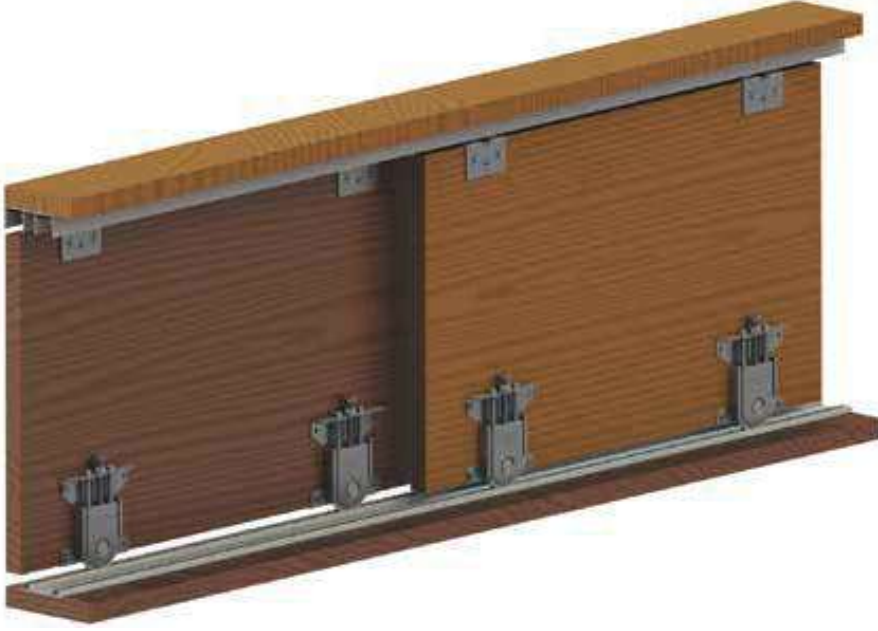

UNS 80 EKO Panel Kapak Mekanizması
UNS80 ECO Sliding Door Mechanism



UNS-DM 9041 Üst Klavuz Sağ
UNS-DM 9041 Top Guide Right



UNS-DM 9041 Üst Klavuz Sol
UNS-DM 9041 Top Guide Left



UNS-DM 9041 Stoper
UNS-DM 9041 Stopper



UNS-DM 9041 Klavuz
UNS-DM 9041 Guide



UNS-OB 9101 Yağlı Fren
UNS-OB 9101 Oil Brake

UNS-DM 9041 Alüminyum Alt ve Üst Rayları
UNS-DM 9041 Aluminium Top and Bottom Rails

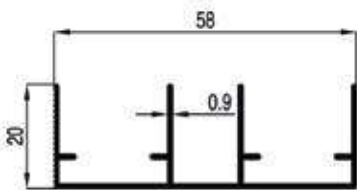

92639

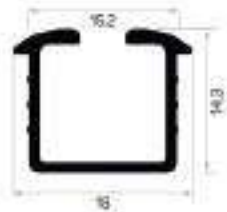

91017

UNS 80 EKO Sürme Kapak Mekanizması
UNS 80 ECO Sliding Door Mechanism



UNS-STP 80 Stoer
UNS-STP 80 Stopper

UNS 80 EKO Sürme kapak Mekanizması **Ağırlık Kapasitesi; 80 Kg. İçindekiler; 2 adet stoper (isteğe bağlı), 4 adet kutuda, 192 adet kolide.**

UNS 80 ECO Sliding Door Mechanism Loading Capacity; 80 Kg. Contents; 4 pcs in the packs - 192 pcs are in the boxes. Stoppers are depends on the request of the customers.

UNS 85 Sürme Kapak Mekanizması
UNS 85 Sliding Door Mechanism



UNS-STP 80 Stoer
UNS-STP 80 Stopper

UNS 85 EKO Sürme kapak Mekanizması **Ağırlık Kapasitesi; 80 Kg. İçindekiler; 2 adet stoper (isteğe bağlı), 4 adet kutuda, 192 adet kolide.**

UNS 85 ECO Sliding Door Mechanism Loading Capacity; 80 Kg. Contents; 4 pcs in the packs - 192 pcs are in the boxes. Stoppers are depends on the request of the customers.

UNS 90 Sürme Kapak Mekanizması
UNS 90 Sliding Door Mechanism



UNS-STP 80 Stoer
UNS-STP 80 Stopper

UNS 90 Sürme kapak Mekanizması **Ağırlık Kapasitesi; 80 Kg. İçindekiler; 2 adet stoper(isteğe bağlı), 4 adet kutuda, 192 adet kolide.**

UNS 90 Sliding Door Mechanism Loading Capacity; 80 Kg. Contents; 4 pcs in the packs - 192 pcs are in the boxes. Stoppers are depends on the request of the customers.

UNS 100 Sürme Kapak Mekanizması
UNS 100 Sliding Door Mechanism



UNS-STP 80 Stoer
UNS-STP 80 Stopper

UNS 100 Sürme kapak Mekanizması **Ağırlık Kapasitesi; 100 Kg. İçindekiler; 2 adet stoper(isteğe bağlı), 4 adet kutuda, 120 adet kolide.**

UNS 100 Sliding Door Mechanism Loading Capacity; 100 Kg. Contents; 4 pcs in the packs - 120 pcs are in the boxes. Stoppers are depends on the request of the customers.

Tüm sürgü teker ürünlerimizde talep ettiğiniz çeşitlilikte; kilitli , somun perçinli, demir pimli vb. olmak üzere üretimimiz mevcuttur.

In the variety you demand in all our sliding door mechanism; we have productions as of locked , nut rivet , iron pin etc.

UNS-ASC 9000 Hız Ayarlı Fren
UNS-ASC 9000 Adjustable Soft Close Brake



UNS-ASC 9000– Hız Ayarlı Fren
Ağırlık; Max. 80 Kg.
Koli İçeriği; 50 Takım

UNS-ASC 9000 Adjustable Soft Close Brake
Load bearing capacity;80 kg
Box Contents; 50 Sets

UNS-AB 9202 Yağlı Fren
UNS-AB 9202 Oil Brake



UNS-OB 9202-Yağlı Fren
Ağırlık; Max. 80 Kg.
Koli içeriği; 140 Adet

UNS-AB 9202 – Oil Brake
Load bearing capacity; 80 kg
Box Contents; 140 Pcs

UNS-AB 9300 Havalı Fren
UNS-AB 9300 Air Brake



UNS-AB 9300– Havalı Fren
Ağırlık; Max. 80 Kg.
Koli içeriği; 200 Adet

UNS-AB 9300 – Air Brake
Load bearing capacity; 80 kg
Box Contents; 200 Pcs

UNS-RDB 9150 Ray Kapak Freni
UNS-RDB 9150 Rail Door Brake



UNS-RDB 9150 - Ray Kapak Freni
Ağırlık; Max. 80 Kg.
Koli içeriği; 50 Takım

UNS-RDB 9150 – Rail Door Brake
Load bearing capacity; 80 kg
Box Contents; 50 Sets

UNS-OB 9101 Yağlı Fren
UNS-OB 9101 Oil Brake



UNS-OB 9101 – Yağlı Fren
Ağırlık; Max. 60 Kg.
Koli içeriği; 100 Adet

UNS-OB 9101 – Oil Brake
Load bearing capacity; 60 kg
Box Contents; 100 Pcs

UNS-OB 9125 Yağlı Fren
UNS-OB 9125 Oil Brake



UNS-OB 9125 – Yağlı Fren
Ağırlık; Max. 80 Kg.
Koli içeriği; 200 Adet

UNS-OB 9125 – Oil Brake
Load bearing capacity;80 kg
Box Contents; 200 Pcs

UNS-SKS 9080 Sürme Kapı Mekanizması
UNS-SKS 9080 Sliding Door Mechanism



UNS-SKS 9080 Sürme Kapı Mekanizması 80 kg ağır ayarlı sürme kapı mekanizması 25 kg - 80 kg taşıma kapasitelidir. Mobilya ve amerikan pres kapılarında uygulanır. 0-13 mm arasında kapak yüksekliği ayarlanabilir, özel rulman ile sessiz çalışır.

UNS-SKS 9080 Sliding Door Mechanism is a mechanism which works for room doors. Sliding heavy door mechanism has 25-80 kg carrying capacity. It can be used with wooden and American press doors. Highness of door can be adjusted between 0-13mm. It works silently with special bearings.

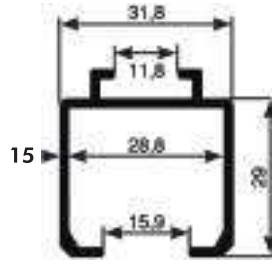

91023 Alt ve Üst Ray
91023 Down and Up Rail



UNS-SKS 9080 Üst Makara
UNS-SKS Upper Roller



UNS-SKS 9080 Alt Klavuz
UNS-SKS Bottom Guide



UNS-SKS 9080 Üst Ray Asma Aparatı
UNS-SKS 9080 Upper Rail Hanging Device



UNS-SKS 9080 Duvar Stoplama Aparatı
UNS-SKS 9080 Wall Stops Apparatus



UNS-SKS 9080 Üst Stoper
UNS-SKS 9080 Upper Stopper

UNS-LT 9730 Led Askı Borusu
UNS-LT 9730 Led Hanger Tube



UNS-LT 9730 LED ASKI BORUSU Ürün Detayı; Gardrop aydınlatma , Hareket sensörlü, Kolay pil değişimi, Standart flanşlar ile kullanılmaktadır. (15 x 30 mm). Ürün üzerinde ayrıca açma kapama tuşları bulunmaktadır.

Ölçüler; 400 mm – 1300 mm arası üretilmektedir.

Malzeme; Alüminyum ve Plastik, Led Renkleri; Beyaz ve Gün ışığı.

Koli içeriği; 20 Adet

UNS-LT 9730 LED LIGHTING TUBE WITH BATTERY Product details; Wardrobe light , Movement Sensor, Easy to Change to the Battery without to take off the clothes on it. Usable for standart flanges (15x 30 mm.). Product has on&off Switches on it.

Sizes; 400 mm. – 1300 mm.

Material; Aluminium and Plastic Led Color; White – Warm White

Box Contents; 20 Pcs

UNS-TR 9740 Pantolon Akılığı
UNS-TR 9740 Trousler Rack



UNS-TR 9740 Pantolon Askılığı

Ölçü; 400 mm – 650 mm arası üretilmektedir.

Renk; Gri ve Beyaz

Yük kapasitesi; 15 kg.

Kurulum; Tabla altı ve yan dikmelerde montaj yapabilirsiniz.

Koli içeriği; Ölçüye göre değişmektedir.

UNS-TR 9740 –Trousler Rack

Material; Aluminium pipes,

Housing; Plastic

Color; Grey - Cream **Sizes;** 400 mm. – 650 mm.

Load bearing capacity; 15 kg **Installation;** Below of the panel or sides

Box Contents; Depends on the sizes.

UNS-TR 9750 Sepetli Pantolon Akılığı
UNS-TR 9750 Trousler Rack With Basket



UNS-TR 9750 Sepetli Pantolon Askılığı

Ölçü; 500 mm – 750 mm arası üretilmektedir.

Renk; Gri ve Beyaz

Yük kapasitesi; 15 kg.

Kurulum; Tabla altı ve yan dikmelerde montaj yapabilirsiniz.

Koli içeriği; Ölçüye göre değişmektedir.

UNS-TR 9750 –Trousler Rack With Basket

Color; Grey - Cream

Sizes; 500 mm. – 750 mm.

Load bearing capacity; 15 kg

Installation; Below of the panel or sides

Box Contents; Depends on the sizes.

UNS-WL 9720 Gardrop Asansörü
UNS-WL 9720 Wardrobe Lift



UNS-WL 9720 Gardrop Asansörü
Renk; Siyah – Beyaz – Gri
İç Ayar; 750 mm – 1170 mm.
Yük Kapasitesi; 15 kg.
Koli İçeriği; 10 Takım

**UNS-WLL 9720 - Manuel Ward-
robe Lift**
Color; Black – White – Grey
Adjustment; 750 mm to 1170 mm.
Load bearing capacity; 15 kg Box
Contents; 10 Sets

UNS-TS 5100 Tek Kanatlı Masa Rayı
UNS-TS 5100 Single Wign Table Slide



Ölçüler ; 800mm,
1000mm, 1200mm ve
özel ölçü
Dimension ; 800mm,
1000mm, 1200mm and
special lenght

UNS-TS 5200 Çift Kanatlı Masa Rayı
UNS-TS 5200 Double Wign Table Slide



Ölçüler ; 800mm,
1000mm, 1200mm ve özel
ölçü
Dimension ; 800mm,
1000mm, 1200mm and
special lenght

UNS-PS 5300 Ortadan Bağlantılı Çek-Ger
UNS-PS 5300 Metal Pull Stretch



Dolap kapaklarının dönme problemini engeller ve
düzgün çalışmasını sağlar. Min. 1910mm - Max.
1940mm

It prevents the rotation problem of the doors and
enables smooth work. Min. 1910mm - Max.
1940mm



Bağlantı Çubuğu
Conenction Bar



Gergi Çubuğu
Tension Bar



Bağlantı Kapağı
Conenction Cover



Gizleme Kelepçesi
Hiding Clips



PVC Çubuk Gizleme Profili
PVC Bar Hiding Profile

UNS-PS 5400 Üstten Bağlantılı Çek-Ger
UNS-PS 5400 Metal Pull Stretch



Dolap kapaklarının dönme problemini engeller ve düzgün
çalışmasını sağlar. Ölçüsü 2000mm'dir. Ayarlama tek taraftan
yapılır.

It prevents the rotation problem of the doors and enables smooth
work. 2000 mm. Adjustment is made from one side.



Gergi Çubuğu
Tension Bar



Gizleme Kelepçesi
Hiding Clips



PVC Çubuk Gizleme Profili
PVC Bar Hiding Profile

UNS-STD Sürgü Kapak Mekanizması UNS-STD Sliding Door Mechanism



Üst Klavuz (Ayarlı)
Upper Guide (Adjustable)



Üst Klavuz (Bilya)
Upper Guide (Bearing)



Üst Klavuz (Silikonlu)
Upper Guide (Silicon)



Üst Klavuz (Oring)
Upper Guide (Oring)



Alt Stoper
Bottom Stopper



Standart Teker (Gama)
Standart Roller (Gama)

OR



Standart Teker (Beta)
Standart Roller (Beta)

UNS-SPR Sürgü Kapak Mekanizması UNS-SPR Sliding Door Mechanism



Üst Klavuz (Ayarlı)
Upper Guide (Adjustable)



Üst Klavuz (Bilya)
Upper Guide (Bearing)



Üst Klavuz (Silikonlu)
Upper Guide (Silicon)



Üst Klavuz (Oring)
Upper Guide (Oring)

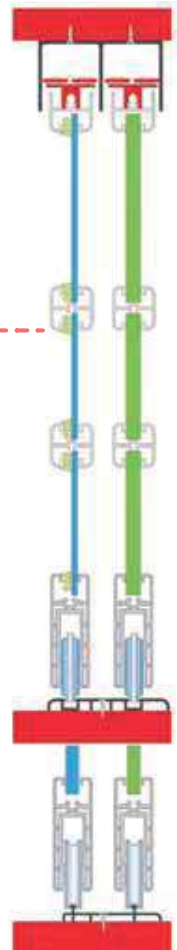

Alt Stoper
Bottom Stopper



Standart Teker (Gama)
Standart Roller (Gama)

OR



Spring Çiftli Teker (Gama)
Spring Double Roller (Gama)

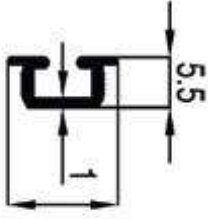

91039

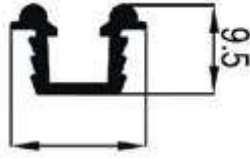

93001

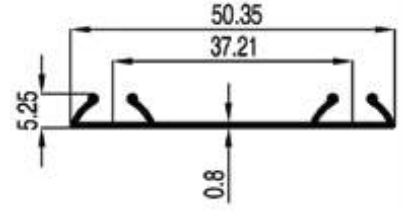

93012

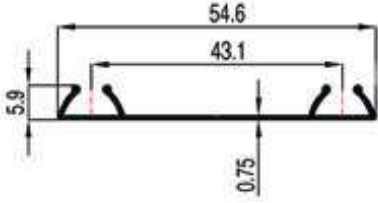

92009

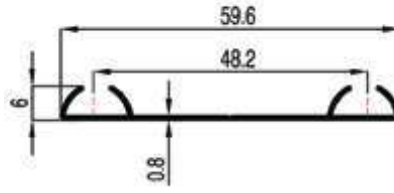

92010

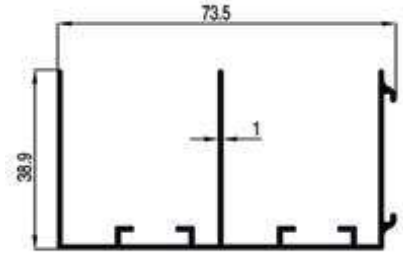

93017

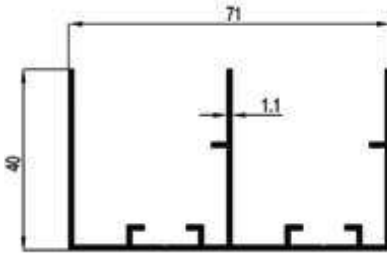

92509

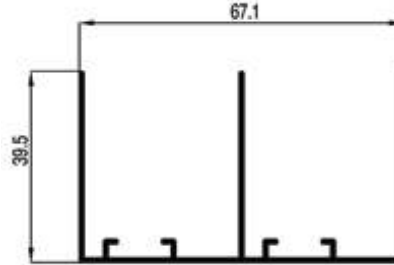

92645

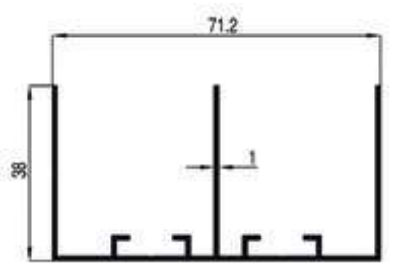

92551

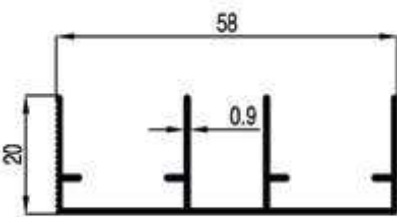

92639

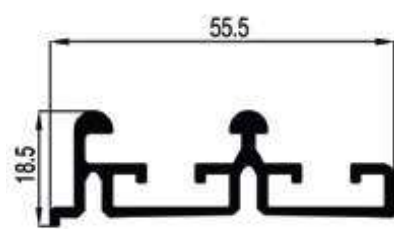

92820

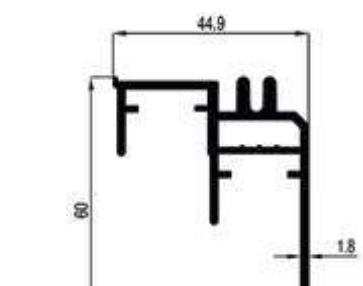

92821

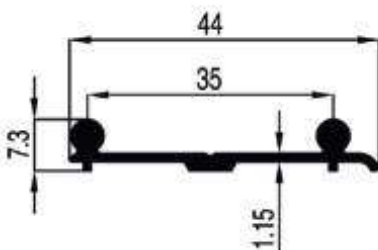

91059

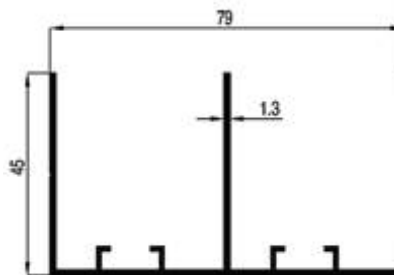

91217

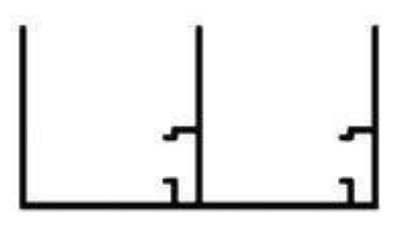

92057

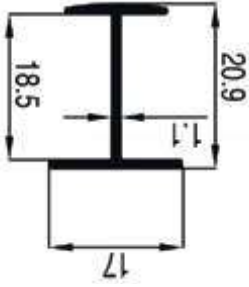

91222

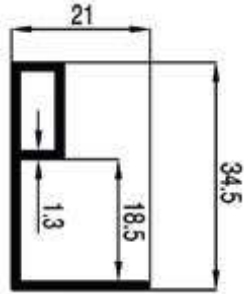

91223

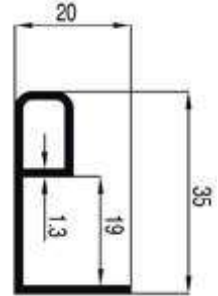

92268

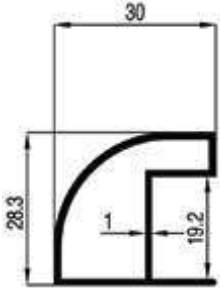

92295

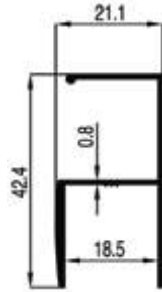

92310

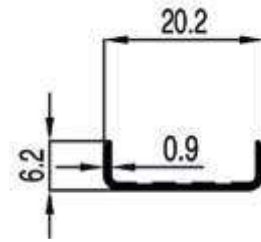

92562

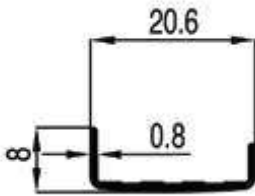

92642

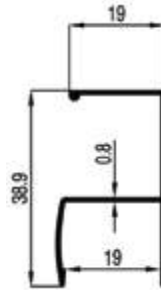

92646



92650

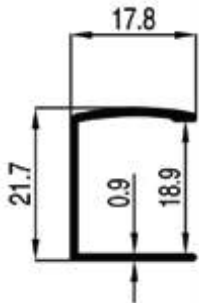

92952

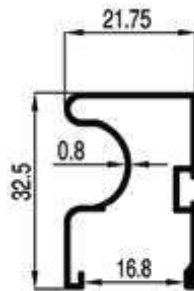

92955

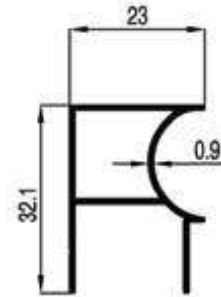

92959

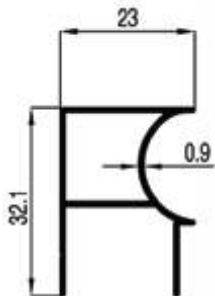

92973

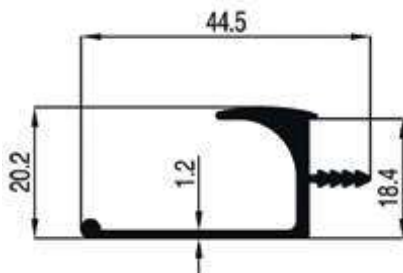

91602

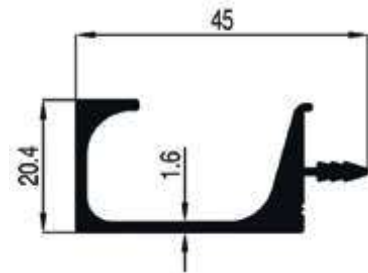

92612



73013

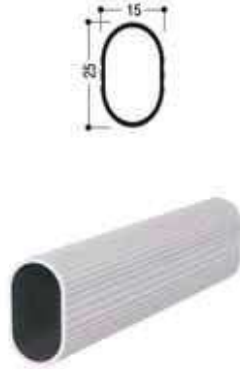

73014



73015



73016

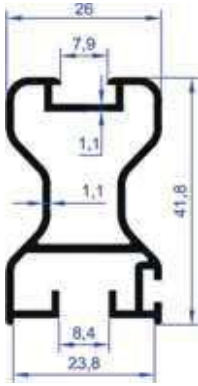

73100 Geniş Kulp

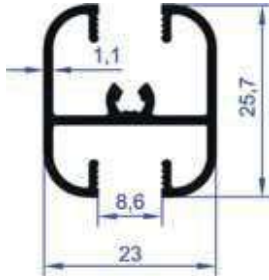

73120 Orta Bağlantı

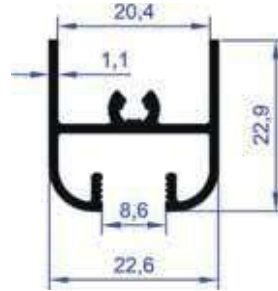

73130 Üst Bağlantı

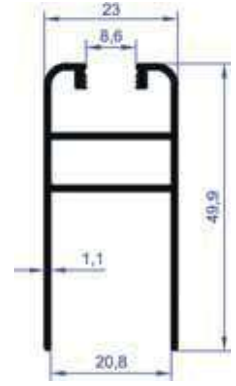

73140 Alt Bağlantı

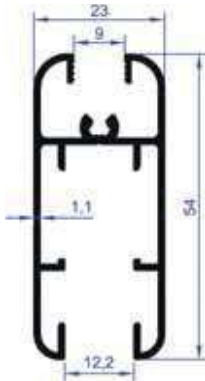

73150 Alt Bağlantı

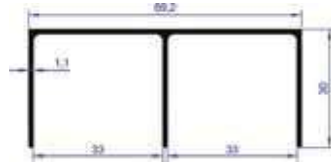

73210 Üst Ray

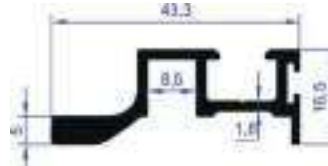

73500 Geniş Yan Kulp

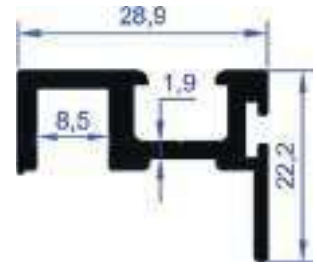

73520 Dar Yan Kulp



73530 Standart Yan Kulp



73550 Alt Üst Bağlantı

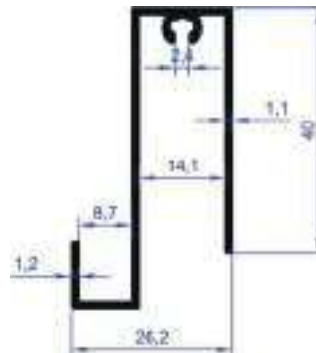

73560 Alt Üst Bağlantı



73570 Alt Ray



ALUMINIUM HANDLES SYSTEMS



UNIS
BUSINESS

UNS-81500 Apaçi Entegre Kulp
UNS-81500 Apache Integrated Handle

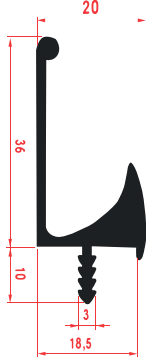

Dimension

197mm	697mm
297mm	797mm
374mm	897mm
397mm	997mm
447mm	1197mm
497mm	3000mm
547mm	
597mm	

UNS-81503 Oval Taşmalı Kulp
UNS-81503 Radius Leash Integrated Handle

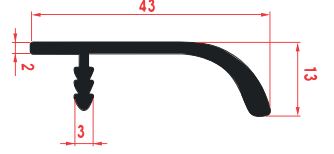
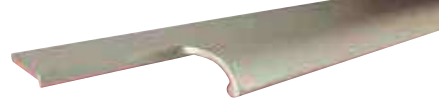

Dimension

197mm	697mm
297mm	797mm
374mm	897mm
397mm	997mm
447mm	1197mm
497mm	3000mm
547mm	
597mm	

UNS-81501 Ç Entegre Kulp
UNS-81501 Ç Type Integrated Handle

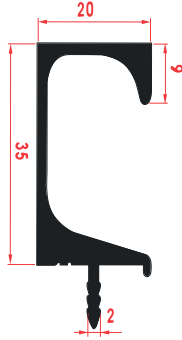

Dimension

197mm	697mm
297mm	797mm
374mm	897mm
397mm	997mm
447mm	1197mm
497mm	3000mm
547mm	
597mm	

UNS-81504 45° Taşmalı Entegre Kulp
UNS-81504 45° Leash Integrated Handle

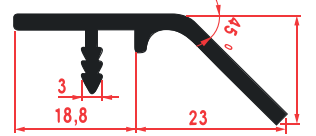

Dimension

197mm	697mm
297mm	797mm
374mm	897mm
397mm	997mm
447mm	1197mm
497mm	3000mm
547mm	
597mm	

UNS-81502 Taşmalı Entegre Kulp
UNS-81502 Leash Integrated Handle

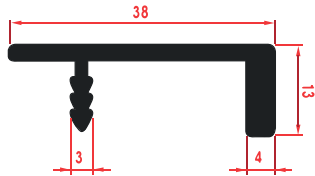
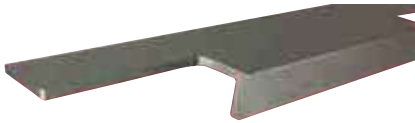

Dimension

197mm	697mm
297mm	797mm
374mm	897mm
397mm	997mm
447mm	1197mm
497mm	3000mm
547mm	
597mm	

UNS-81505 45° Taşmalı Entegre Kulp
UNS-81505 45° Leash Integrated Handle

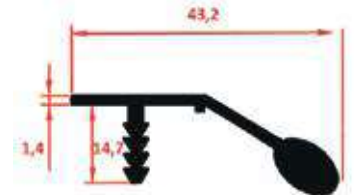

Dimension

197mm	697mm
297mm	797mm
374mm	897mm
397mm	997mm
447mm	1197mm
497mm	3000mm
547mm	
597mm	

UNS-81506 Sürme Taşmalı Entegre Kulp
UNS-81506 Leash Integrated Handle

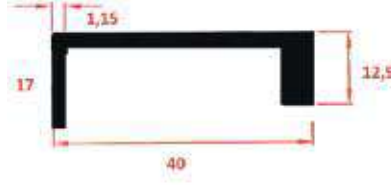

Dimension

197mm	697mm
297mm	797mm
374mm	897mm
397mm	997mm
447mm	1197mm
497mm	3000mm
547mm	
597mm	

UNS-81507 Oval Taşmalı Entegre Kulp
UNS-81507 Radius Leash Integrated Handle

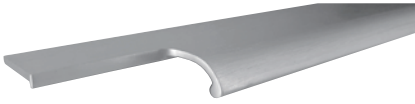

Dimension

197mm	697mm
297mm	797mm
374mm	897mm
397mm	997mm
447mm	1197mm
497mm	3000mm
547mm	
597mm	

UNS-81508 45° Taşmalı Entegre Kulp
UNS-81508 45° Leash Integrated Handle



Dimension

197mm	697mm
297mm	797mm
374mm	897mm
397mm	997mm
447mm	1197mm
497mm	3000mm
547mm	
597mm	

UNS-81509 L Entegre Kulp
UNS-81509 L Type Integrated Handle

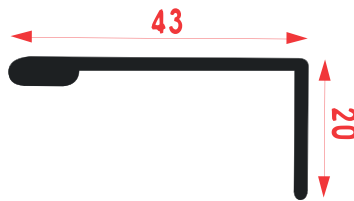

Dimension

197mm	697mm
297mm	797mm
374mm	897mm
397mm	997mm
447mm	1197mm
497mm	3000mm
547mm	
597mm	

UNS-81510 Taşmalı Entegre Kulp
UNS-81510 Leash Integrated Handle

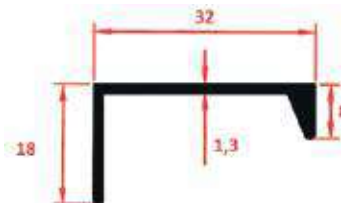

Dimension

197mm	697mm
297mm	797mm
374mm	897mm
397mm	997mm
447mm	1197mm
497mm	3000mm
547mm	
597mm	



ALUMINIUM FRAME COVER SYSTEMS



UNIS
BUSINESS

UNS-FC 80 Çerçeve Kapak
UNS-FC 80 Frame Cover

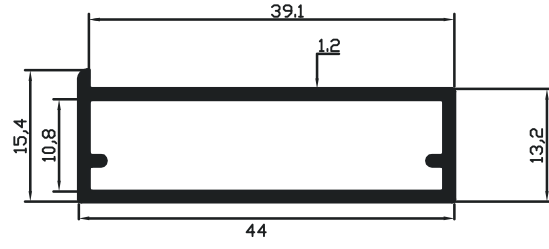

UNS-FC 81 Çerçeve Kapak
UNS-FC 81 Frame Cover

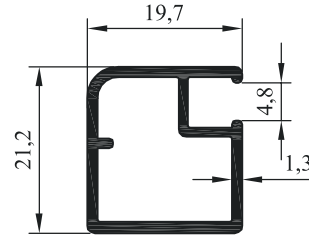
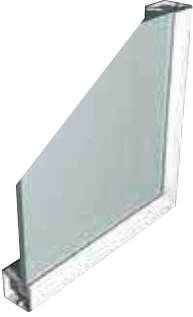

UNS-FC 82 Çerçeve Kapak Kulplu
UNS-FC 82 Frame Cover With Handle

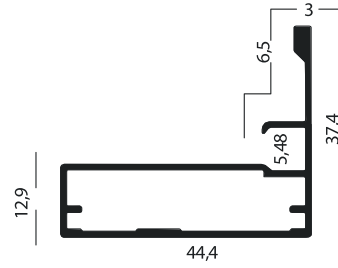

UNS-FC 83 Çerçeve Kapak Kulplu
UNS-FC 83 Frame Cover With Handle

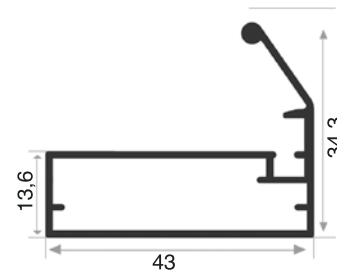

UNS-FC 84 Çerçeve Kapak
UNS-FC 84 Frame Cover

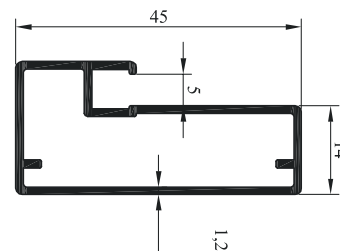



KITCHEN SYSTEMS



UNIS
BUSINESS

UNS-81541 10cm PVC Baza Profil
UNS-81541 10cm PVC Plinth Profile

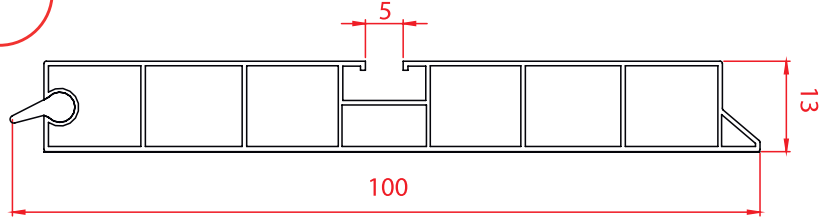
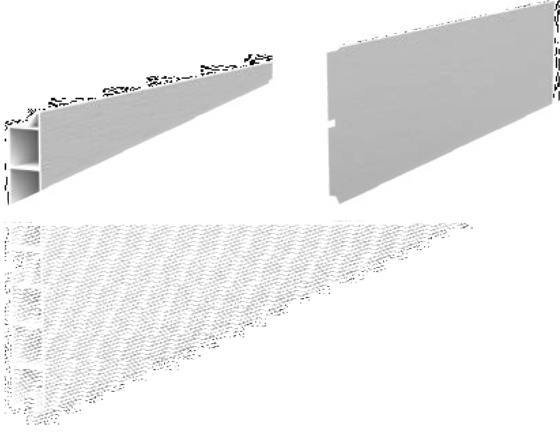

Packing Specification

Code	Height (mm)	Lenght (mm)	PCS	Net Weight (kg)	Gross Weight (kg)	Width x Lenght x Height (cm)
UNS-81541	100	4000	15	20	22	22x408x11

UNS-81542 12cm PVC Baza Profil
UNS-81542 12cm PVC Plinth Profile

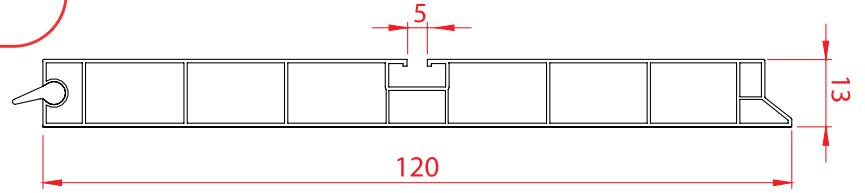
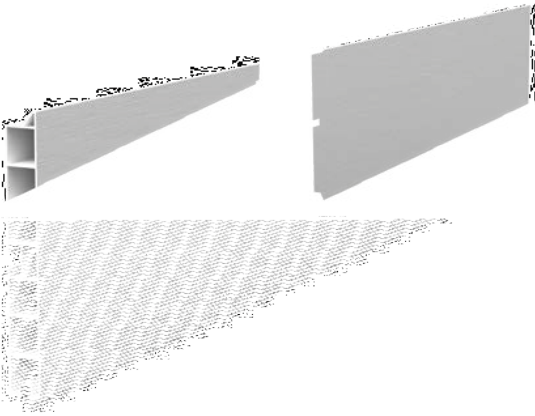

Packing Specification

Code	Height (mm)	Lenght (mm)	PCS	Net Weight (kg)	Gross Weight (kg)	Width x Lenght x Height (cm)
UNS-81542	120	4000	15	24	26	22x408x13

UNS-81543 15cm PVC Baza Profil
UNS-81543 15cm PVC Plinth Profile

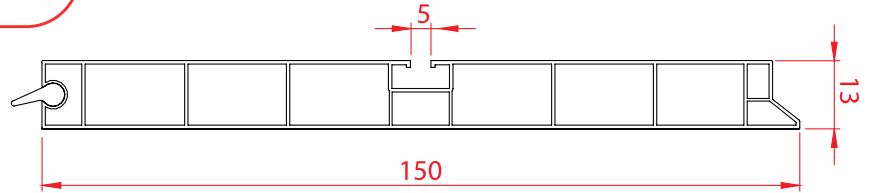
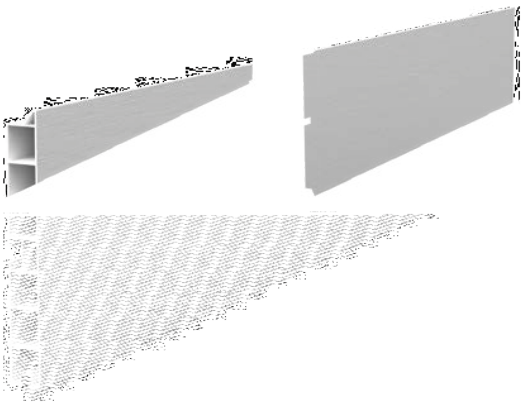

Packing Specification

Code	Height (mm)	Lenght (mm)	PCS	Net Weight (kg)	Gross Weight (kg)	Width x Lenght x Height (cm)
UNS-81543	150	4000	15	31	33	22x408x16

PVC Baza Aksesuarlar
PVC Plinth Accessories

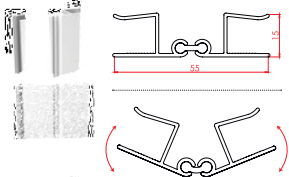

UNS-81544.10/12/15 Ayarlı Baza Köşe
UNS-81544.10/12/15 Adjustable PVC Plinth Corner

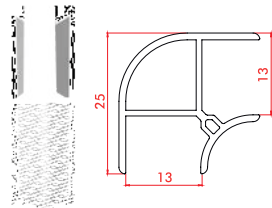

UNS-81545.10/12/15 90° Baza Köşe
UNS-81545.10/12/15 90° Plinth Corner

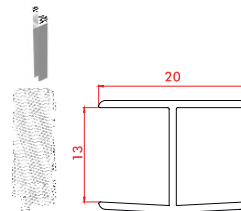

UNS-81546.10/12/15 Baza Ara Birleştirici
UNS-81546.10/12/15 PVC Plinth Joint

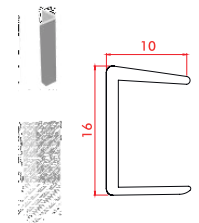

UNS-81547.10/12/15 Baza Köşe Kapama
UNS-81547.10/12/15 PVC Plinth End Cap

UNS-81564 10-15 cm Ayarlanabilir Baza Ayağı
UNS-81564 10-15 cm Adjustable Plinth Legs



UNS-81564.01 Siyah Ayarlanabilir Baza Ayağı /
10-15 cm / 15-20 cm Koli İçeriği; 300 Adet

UNS-81564.01 Black Adjustable Plinth Leg / from
10 cm. to 15 cm / from 15 cm. to 20cm. Box
Contents; 300 Pcs



UNS-81564.02 Beyaz Ayarlanabilir Baza Ayağı /
10-15 cm /15-20 cm Koli İçeriği; 300 Adet

UNS-81564.02 White Adjustable Plinth Leg / from
10 cm. to 15 cm / from 15 cm. to 20 cm. Box
Contents; 300 Pcs



UNS-81564.02 Beyaz Ayarlanabilir Baza Ayağı /
10-15 cm /15-20 cm Koli İçeriği; 300 Adet

UNS-81564.02 White Adjustable Plinth Leg / from
10 cm. to 15 cm / from 15 cm. to 20 cm. Box
Contents; 300 Pcs



UNS-81565 Baza Klips
UNS-81565 Plinth Clips

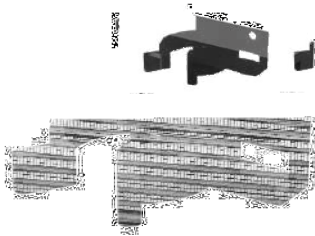

UNS-81565 Ahşap Baza Klipsi
UNS-81565 Holder Clips for Wooden Plinth



UNS-81565.01 Baza Klipsi
UNS-81565.01 PVC Plinth Clips

UNS-81571 İçbükey Süpügelik
UNS-81571 PVC Concave Skirting

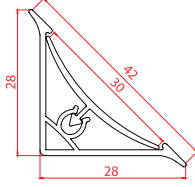

81571.01

Packing Specification							
Code	Height (mm)	Lenght (mm)	PCS	Metraj (for 1 box)	Net Weight	Gross Weight	Width x Lenght x Height (cm)
UNS-81571	28	4000	30	120	19	20,5	22x408x7



UNS-81581 T Model Süpügelik
UNS-81581 PVC T Model Skirting

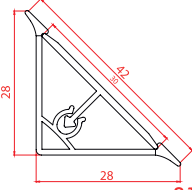

81581.01

Packing Specification							
Code	Height (mm)	Lenght (mm)	PCS	Metraj (for 1 box)	Net Weight	Gross Weight	Width x Lenght x Height (cm)
UNS-81581	27	4000	30	120	19	20,5	22x408x7



UNS-81591 Mini Sistem Süpügelik
UNS-81591 PVC Mini System Skirting

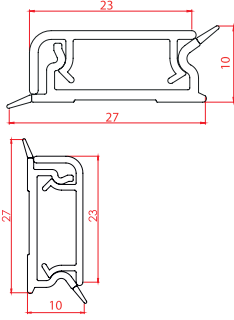

81591.01

Packing Specification							
Code	Height (mm)	Lenght (mm)	PCS	Metraj (for 1 box)	Net Weight	Gross Weight	Width x Lenght x Height (cm)
UNS-81591	27/10	4000	20	80	19	20,5	22x408x7



UNS-81601 S Model Süpügelik
UNS-81601 PVC S Model Skirting

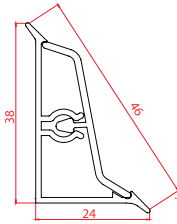

81601.01

Packing Specification							
Code	Height (mm)	Lenght (mm)	PCS	Metraj (for 1 box)	Net Weight	Gross Weight	Width x Lenght x Height (cm)
UNS-81601	38	4000	40	160	32,5	20,5	22x408x7



UNS-81611 36mm Dış bükey Süpügelik
UNS-81611 PVC 36mm Convex Skirting

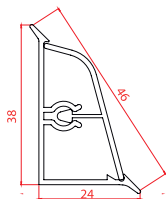

81611.01

Packing Specification							
Code	Height (mm)	Lenght (mm)	PCS	Metraj (for 1 box)	Net Weight	Gross Weight	Width x Lenght x Height (cm)
UNS-81611	38	4000	30	80	19	20,5	22x408x11



UNS-81631 30mm Ara Birleştirme
UNS-81631 30mm Joining Strip

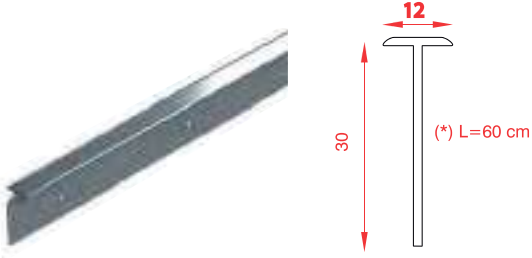

Accessories Packing Specification			
Code	PCS	1 Box Weight	WxLxH (cm)
UNS-81631	250	21	15x40x60



UNS-81634 30mm Ara Birleştirme
UNS-81634 30mm Joining Strip

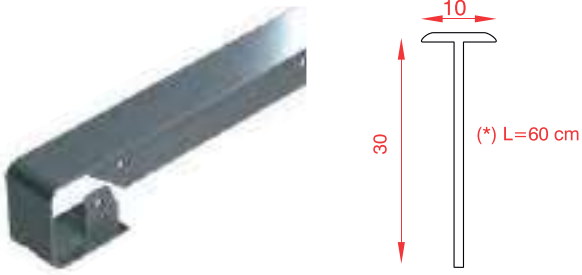

Accessories Packing Specification			
Code	PCS	1 Box Weight	WxLxH (cm)
UNS-81634	x	x	x



UNS-81635 40mm Ara Birleştirme
UNS-81635 40mm Joining Strip

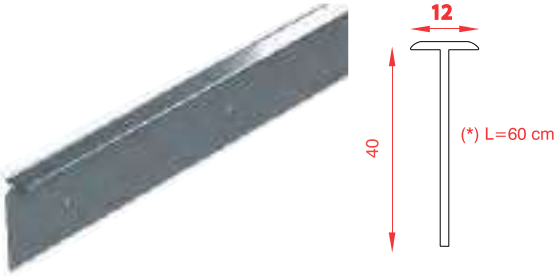

Accessories Packing Specification			
Code	PCS	1 Box Weight	WxLxH (cm)
UNS-81635	250	24	15x40x60



UNS-81639 30mm Köşe Birleştirme
UNS-81639 30mm Joining Corner

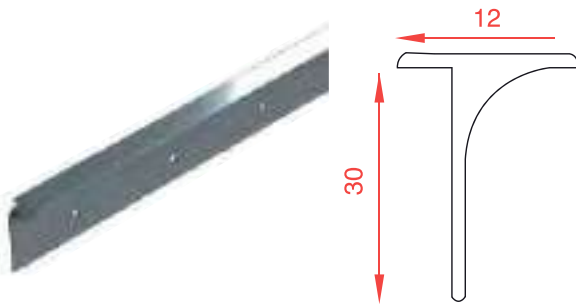

Accessories Packing Specification			
Code	PCS	1 Box Weight	WxLxH (cm)
UNS-81639	250	19	15x40x60



UNS-81641 30mm Köşe Birleştirme
UNS-81641 30mm Joining Corner

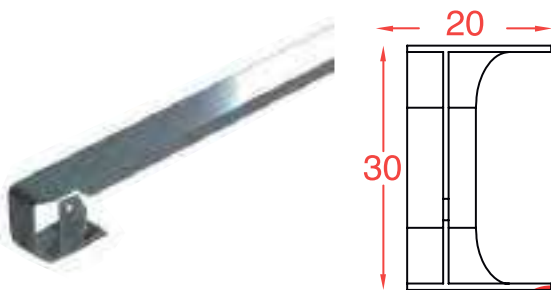

Accessories Packing Specification			
Code	PCS	1 Box Weight	WxLxH (cm)
UNS-81641	x	x	x



UNS-81643 40mm Köşe Birleştirme
UNS-81643 40mm Joining Corner

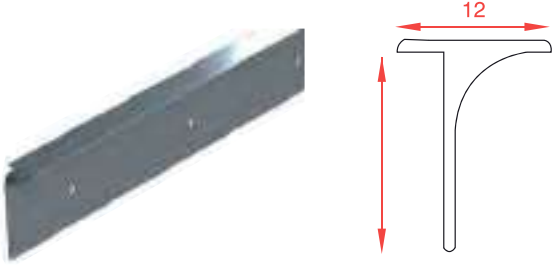

Accessories Packing Specification			
Code	PCS	1 Box Weight	WxLxH (cm)
UNS-81643	250	23	15x40x60

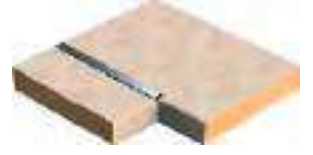

UNS-81647 32mm Çizgili Bitim Kapama
UNS-81647 32mm Striped End Cap

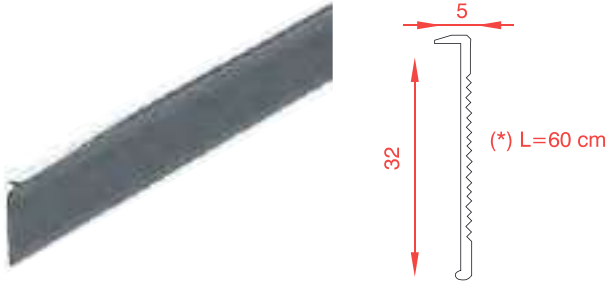

Accessories Packing Specification			
Code	PCS	1 Box Weight	WxLxH (cm)
UNS-81647	250	32	15x40x60



UNS-81648 30mm Bitim Kapama
UNS-81648 30mm End Cap

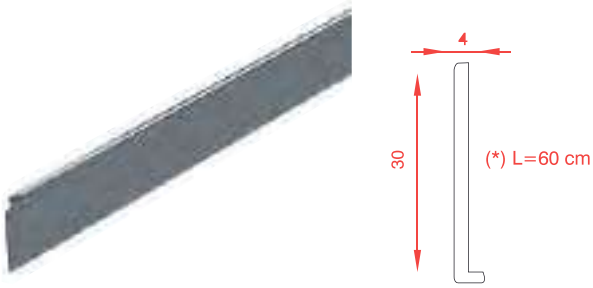

Accessories Packing Specification			
Code	PCS	1 Box Weight	WxLxH (cm)
UNS-81648	250	35	15x40x60



UNS-81649 40mm Çizgili Bitim Kapama
UNS-81649 40mm Striped End Cap

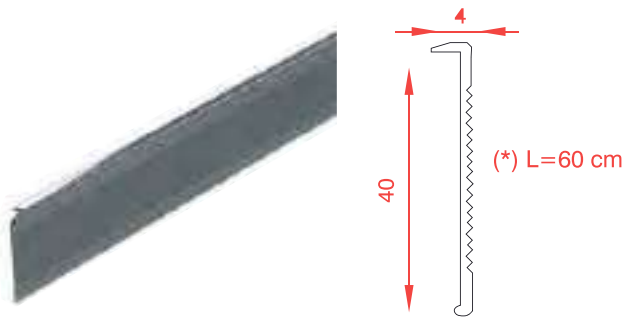

Accessories Packing Specification			
Code	PCS	1 Box Weight	WxLxH (cm)
UNS-81649	250	37	15x40x60



UNS-81650 40mm Bitim Kapama
UNS-81650 40mm End Cap

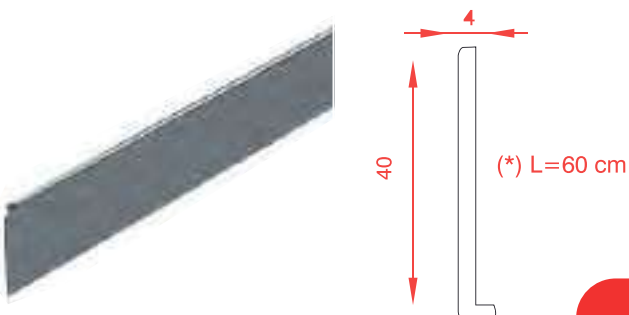

Accessories Packing Specification			
Code	PCS	1 Box Weight	WxLxH (cm)
UNS-81650	250	40	15x40x60



UNS-81631 30mm Ara Birleştirme
UNS-81631 30mm Joining Strip

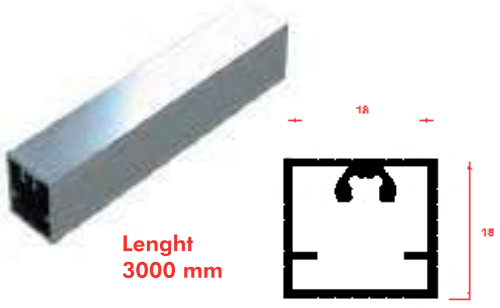

Lenght
3000 mm

UNS-81521 Gola Yatay L Profili
UNS-81521 Gola Horizontal L Profile

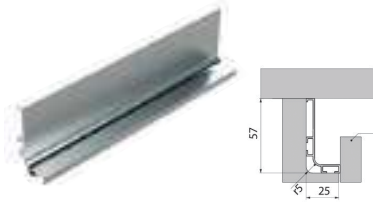

Lenght
4200 mm

UNS-81525 Gola Fitilli Üst Profili
UNS-81525 Gola Upper Profile With Rubber

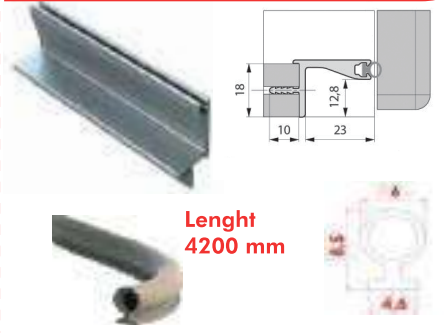

Lenght
4200 mm

UNS-81634 30mm Ara Birleştirme
UNS-81634 30mm Joining Strip

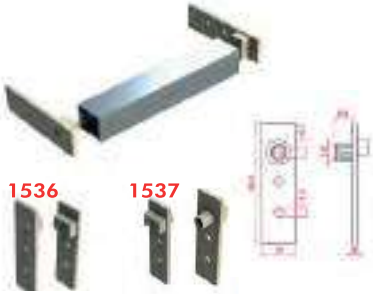

1536

1537

UNS-81522 Gola Yatay U Profili
UNS-81522 Gola Horizontal U Profile

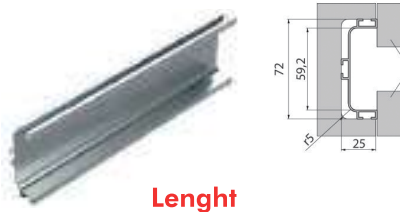

Lenght
4200 mm

UNS-81526 Gola Fitilsiz Üst Profili
UNS-81526 Gola Upper Profile

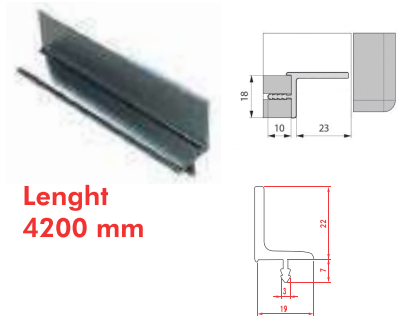

Lenght
4200 mm

UNS-81635 40mm Ara Birleştirme
UNS-81635 40mm Joining Strip



Lenght
3000 mm

UNS-81523 Gola Diley L Profili
UNS-81523 Gola Vertical L Profile

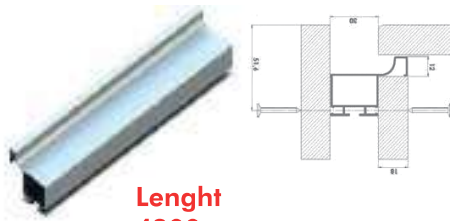

Lenght
4200 mm

UNS-81528 Gola Profil Kapakları
UNS-81528 Gola Profile End Caps



1528

1531

1532

UNS-81639 30mm Köşe Birleştirme
UNS-81639 30mm Joining Corner



1492

1536

1537

UNS-81524 Gola Diley U Profili
UNS-81524 Gola Vertical U Profile

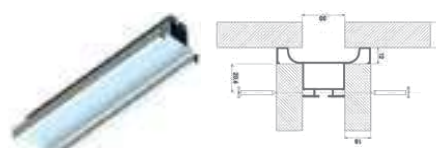

Lenght
4200 mm

UNS-81529 Gola Profili Bağlantı Plastik Aparatı
UNS-81529 Gola Profile Plastic Connector



UNS-81527 Gola Profili Bağlantı Demiri
UNS-81527 Gola Profile Connector



1527

UNS-86321 Çöp Kovası
UNS-86321 Dustbin



Code	Description	Size Cm	PCS
86321	Dustbin In Cabinet Chrome Black	11 LT	12

UNS-8600 Desenli Gri Kaşıklik
UNS-8600 Patterned Grey Cutlery



Code	Description	Size Cm	PCS
86003049	UNS-8600 Patterned Grey Cutlery	30x49	15
86003749		37x49	15
86004249		42x49	15
86004749		47x49	15
86005549		55x49	15
86006249		62x49	15
86006749		67x49	15
86007549		75x49	15
86008549		85x49	15
86009749		97x49	15

UNS-8601 Parlak Gri Kaşıklik
UNS-8601 Shiny Grey Cutlery



Code	Description	Size Cm	PCS
86013049	UNS-8601 Shiny Grey Cutlery	30x49	15
86013749		37x49	15
86014249		42x49	15
86014749		47x49	15
86015549		55x49	15
86016249		62x49	15
86016749		67x49	15
86017549		75x49	15
86018549		85x49	15
86019749		97x49	15

UNS-8602 Mermer Desenli Kaşıklik
UNS-8602 Marble Pattern Cutlery



Code	Description	Size Cm	PCS
86023049	UNS-8602 Marble Pattern Cutlery	30x49	15
86023749		37x49	15
86024249		42x49	15
86024749		47x49	15
86025549		55x49	15
86026249		62x49	15
86026749		67x49	15
86027549		75x49	15
86028549		85x49	15
86029749		97x49	15

UNS-79001 Gizli Köşe Bağlantısı
UNS-79001 Hidden Corner Connection

Size:
1,2mm-1,5mm



Colors:



UNS-79003 Arkalık Sabitleyici
UNS-79003 Back Stabilizer



Colors:



UNS-79005 Plastik Kama
UNS-79005 Base Plate



Colors:



UNS-79007 L Bağlantı
UNS-79007 L Corner Connection



Colors:



UNS-79009 Şeffaf Köşe Çektirme
UNS-79009 Transparent Corner Fittings



Colors:



UNS-79002 Gizli Bağlantı
UNS-79002 Covered Connection



Colors:



UNS-79004 Çekici
UNS-79004 Puller



Colors:



UNS-79006 Kavale
UNS-79006 Kavale



Colors:



UNS-79008 Alyan Vida Kapağı
UNS-79008 Allen Plug



Colors:



UNS-79010 Vida Kapağı
UNS-79010 Minifix Plug



Colors:

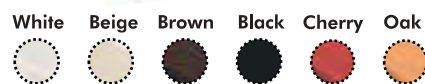

UNS-79011 Metal Çektirme
UNS-79011 Metal Puller



Colors:
Chrome Nickel



UNS-79012 Metal Çektirme
UNS-79012 Metal Puller



Colors:
Chrome Nickel



UNS-79013 Metal Çektirme
UNS-79013 Metal Puller



Colors:
Chrome Nickel



UNS-79014 Metal Çektirme
UNS-79014 Metal Puller



Colors:
Chrome Nickel



UNS-79015 Metal Vida Kapağı
UNS-79015 Metal Plug

Size:
15s-20s-25s



Colors:
Chrome



UNS-79016 Minifiks Gövde
UNS-79016 Minifix Body



Colors:
Chrome Nickel



UNS-79017 Plastik Dübel
UNS-79017 Plastic Dowel

Size:
Ø8x11-Ø10x13



Colors:
White Grey



UNS-79018 Metal Dübel
UNS-79018 Metal Dowel

Size:
Ø8x11-Ø8x13



Colors:
Chrome



UNS-79019 Metal Flanş
UNS-79019 Metal Flange Half



Colors:
Chrome Nickel



UNS-79020 Plastik Oval Flanş
UNS-79020 Plastic Oval Flange



Colors:
White Grey Brown



UNS-79021 Plastik Başlı Metal Raf Pimi
UNS-79021 Metal-Plastic Head Shelf Pin



Colors:

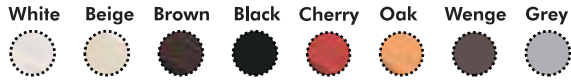

UNS-79023 Çivili Raf Pimi
UNS-79023 Spiked Shelf Pin



Colors:



UNS-79025 Lux Çivili Raf Pimi
UNS-79025 Lux Shelf Pin



Colors:



UNS-79027 Raf Pimi
UNS-79027 Shelf Pin



Colors:



UNS-79029 Gizli Raf Tutucu
UNS-79029 Hidden Shelf Holder



Colors:



UNS-79022 Kristal Raf Pimi
UNS-79022 Crystal Shelf Pin



Colors:



UNS-79024 Vantuzlu Cam Raf Pimi
UNS-79024 Suction Cup Glass Shelf Pin



Colors:



UNS-79026 Çivili Contalı Raf Pimi
UNS-79026 Shelf Pin with Stud Seal



Colors:



UNS-79028 Metal Raf Pimi
UNS-79028 Metal Shelf Pin



Colors:



UNS-79030 Karyola Bağlantı Seti
UNS-79030 Bed Fittings Set



UNS-79031 Oval Askı Borusu
UNS-79031 Oval Hanging Pipe



Colors:
Chrome



UNS-79032 Yuvarlak Askı Borusu
UNS-79032 Round Hanging Pipe



Colors:
Chrome



UNS-79033 Oval Askı Boru Flanşı
UNS-79033 Oval Hanging Pipe Flange



Colors:
Chrome



UNS-79034 Kapalı Oval Askı Flanşı
UNS-79034 Oval Hanging Pipe Flange Closed

Size:
15s-20s-25s



Colors:
Chrome



UNS-79035 Yuvarlak Askı Boru Flanşı
UNS-79035 Round Hanging Pipe Flange



Colors:
Chrome



UNS-79036 Kapalı Yuvarlak Askı Flanşı
UNS-79036 Round Hanging Pipe Flange Closed



Colors:
Chrome



UNS-79037 Yuvarlak Boru Flanşı
UNS-79037 Round Pipe Flange



Colors:
Chrome



UNS-79038 Oval Boru Flanşı
UNS-79038 Oval Pipe Flange



Colors:
Chrome



UNS-79039 2 Delikli Askı Flanşı
UNS-79039 2 Holes Hanger Flange



Colors:
Chrome



UNS-79040 4 Delikli Askı Flanşı
UNS-79040 4 Holes Hanger Flange



Colors:
Chrome



UNS-79041 Bellona Ayak
UNS-79041 Bellona Foot



Colors:



UNS-79042 Vazo Ayak
UNS-79042 Vase Foot



UNS-79043 Küçük Bingo Ayak
UNS-79043 Little Bingo Foot



Colors:



UNS-79044 Bingo Ayak Tutucu
UNS-79044 Bingo Feet Sheet



Colors:



UNS-79045 Tombul Ayak
UNS-79045 Plump Foot



Colors:



UNS-79046 Kolon Ayak
UNS-79046 Column Foot



Size:
5s-8s-10s

Colors:



UNS-79047 Smart Ayak
UNS-79047 Smart Foot



Colors:



UNS-79048 Üçgen Ayak
UNS-79048 Triangle Foot



Colors:



UNS-79049 Bas-Çek Mandal (Tekli)
UNS-79049 Touch Latch (Single)

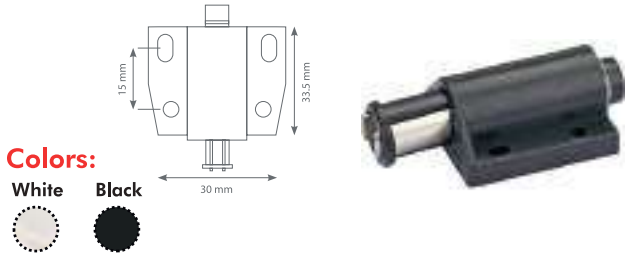

Colors:



UNS-79050 Bas-Çek Mandal (Çift)
UNS-79050 Touch Latch (Double)

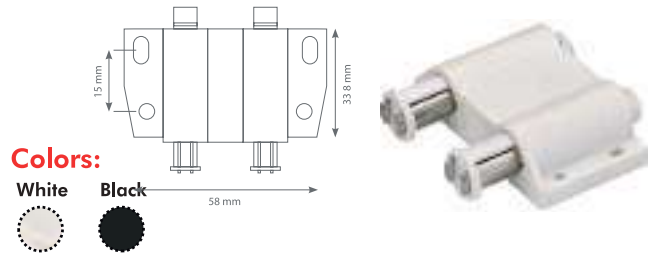

Colors:



UNS-79051 U Cam Kapak Bağlantı Elemanı
UNS-79051 Glass Cover Fastener U Type

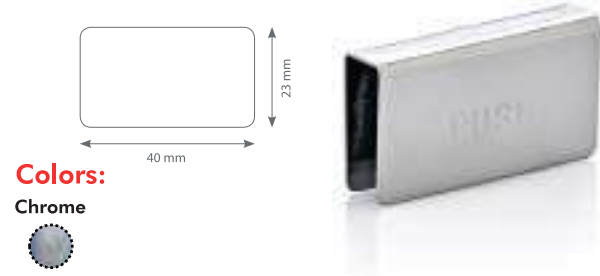

Colors:



UNS-79052 U Cam Menteşesi
UNS-79052 Glass Hinge U Type

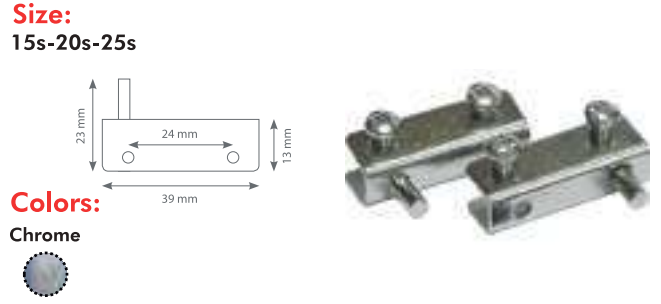

Size:

15s-20s-25s

Colors:



UNS-79053 Bas-Çek Mandal Seti (Tekli)
UNS-79053 Touch Latch Set (Single)

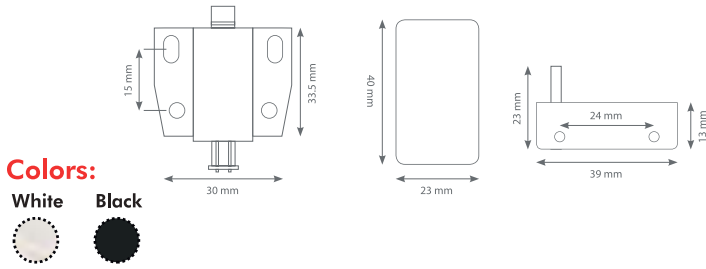

Colors:



UNS-79054 Bas-Çek Mandal Seti (Çift)
UNS-79054 Touch Latch Set (Double)

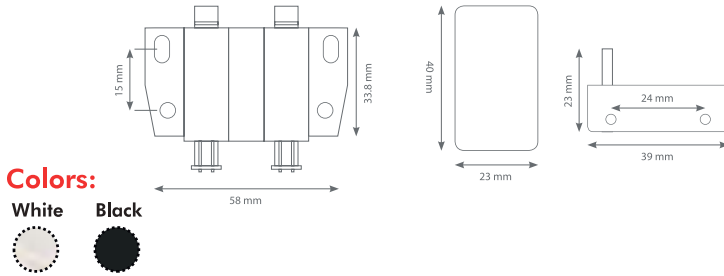

Colors:



UNS-79055 Cam Menteşesi (Büyük)
UNS-79055 Glass Hinge (Big)

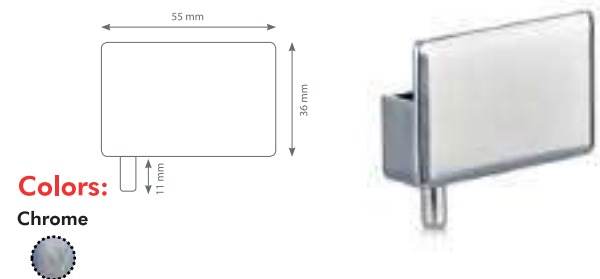

Colors:



UNS-79056 Manyetik Mandal (Küçük)
UNS-79056 Touch Latch Magnetic (Small)

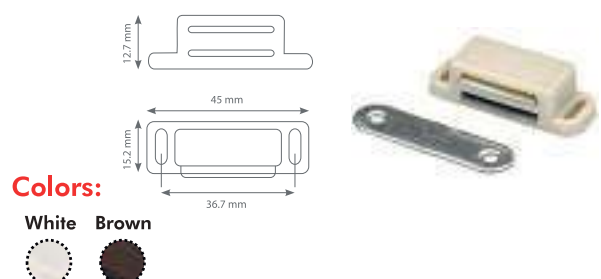

Colors:

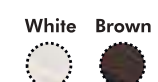

UNS-79057 Manyetik Mandal(Büyük)
UNS-79057 Touch Latch Magnetic (Big)

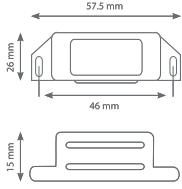

Colors:

White Brown



UNS-79058 Paslanmaz Manyetik Mandal
UNS-79058 Touch Latch Magnetic Stainless

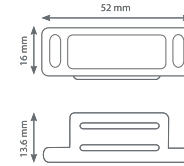

Colors:

Chrome



UNS-79059 Manyetik Mandal 7.5cm
UNS-79059 Touch Latch Magnetic 7.5cm

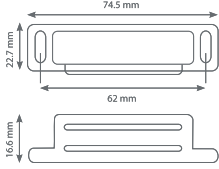

Colors:

White Brown



UNS-79060 Manyetik Mandal 9.5cm
UNS-79060 Touch Latch Magnetic 9.5cm

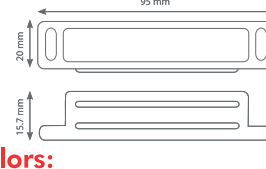

Colors:

White Brown



UNS-79061 Paslanmaz Manyetik Mandal 8.5cm
UNS-79061 Touch Latch Magnetic Stainless 8.5cm

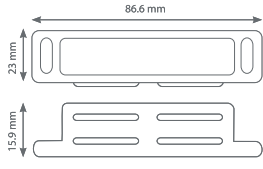

Colors:

Chrome



UNS-79062 Cam Menteşesi (Tekli)
UNS-79062 Glass Hinge (Single)

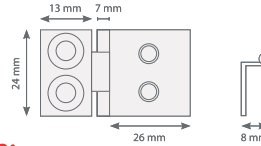

Colors:

Chrome



UNS-79063 Cam Menteşesi 90°
UNS-79063 Glass Hinge 90°

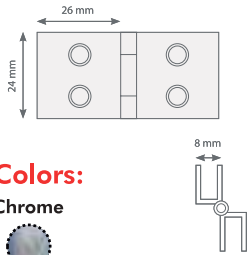

Colors:

Chrome



UNS-79064 Cam Menteşesi
UNS-79064 Glass Hinge

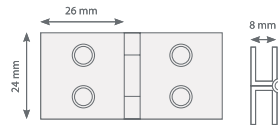

Colors:

Chrome



UNS-79065 Cam Menteşesi 22mm
UNS-79065 Glass Hinge 22mm

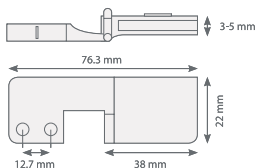

Colors:

Chrome



UNS-79066 Cam Menteşesi 30mm
UNS-79066 Glass Hinge 30mm

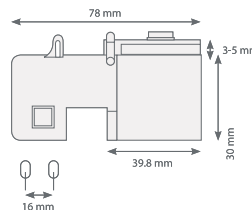

Colors:

Chrome



UNS-79067 Minifix Mili MB-2
UNS-79067 Minifix Bolts MB-2



Code	L	L1	L2	k	D	D1	Color	Unit/gr
MB2P34	43,5	34	9,5	4	6,6	M6	Zinc	6,8
MB2P28	37,5	28	9,5	4	6,6	M6	Zinc	5,8
MB2P24	33,5	24	9,5	4	6,6	M6	Zinc	5,2

UNS-79068 Minifix Mili MB-1
UNS-79068 Minifix Bolts MB-1



Code	L	L1	L2	k	D	D1	Color	Unit/gr
MB1P34	43,5	34	9,5	4	6,6	M6	Zinc	6,8
MB1P28	37,5	28	9,5	4	6,6	M6	Zinc	5,8
MB1P24	33,5	24	9,5	4	6,6	M6	Zinc	5,2

UNS-79069 Minifix Mili MH-2
UNS-79069 Minific Bolts MH-2

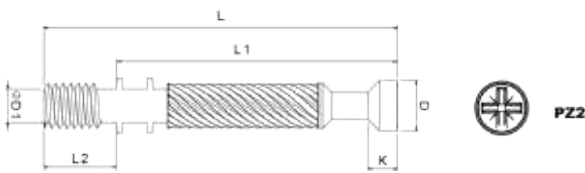

Code	L	L1	L2	k	D	D1	Color	Unit/gr
MH2P34	43,5	34	11	4	6,6	M6	Zinc	6,8
MH2P28	37,5	28	11	4	6,6	M6	Zinc	5,8
MH2P24	33,5	24	11	4	6,6	M6	Zinc	5,2

UNS-79070 Minifix Mili MH-1
UNS-79070 Minific Bolts MH-1

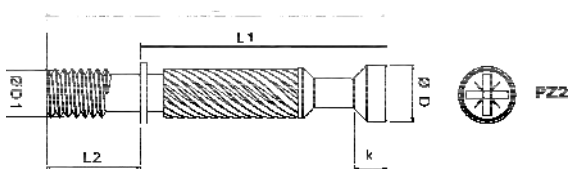

Code	L	L1	L2	k	D	D1	Color	Unit/gr
SH1P34	43,5	34	9,5	4	6,6	M6	Zinc	6,8
SH1P28	37,5	28	9,5	4	6,6	M6	Zinc	5,8
SH1P24	33,5	24	9,5	4	6,6	M6	Zinc	5,2

UNS-79071 Minifix Mili MH-5
UNS-79071 Minifix Bolts MH-5

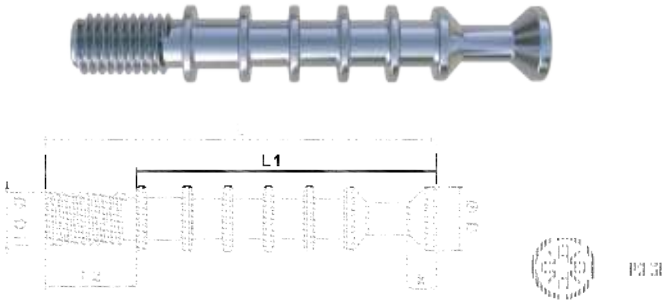

Code	L	L1	L2	k	D	D1	Color	Unit/gr
M5P34	43,5	34	9,5	4	6,6	M6	Zinc	6,8
M5P28	37,5	28	9,5	4	6,6	M6	Zinc	5,8
M5P24	33,5	24	9,5	4	6,6	M6	Zinc	5,2

UNS-79072 Minifix Mili SB-2
UNS-79072 Minifix Bolts SB-2

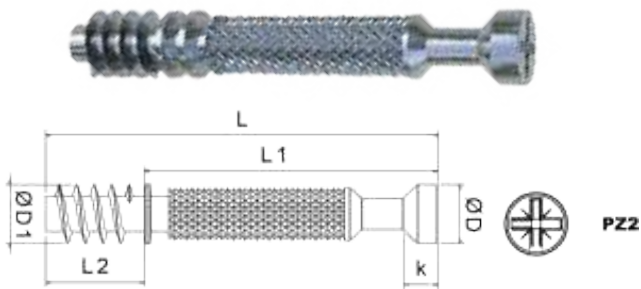

Code	L	L1	L2	k	D	D1	Color	Unit/gr
SB2P34	45	34	11	4	6,6	6,2	Zinc	5,85
SB2P28	39	28	11	4	6,6	6,2	Zinc	4,75
SB2P24	35	24	11	4	6,6	6,2	Zinc	4,3

UNS-79073 Minifix Mili SB-1
UNS-79073 Minifix Bolts SB-1

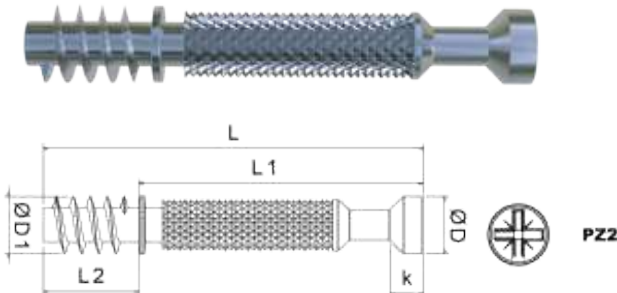

Code	L	L1	L2	k	D	D1	Color	Unit/gr
SB1P34	45	34	11	4	6,6	6,2	Zinc	5,85
SB1P28	39	28	11	4	6,6	6,2	Zinc	4,75
SB1P24	35	24	11	4	6,6	6,2	Zinc	4,3

UNS-79074 Minifix Mili SH-2
UNS-79074 Minifix Bolts SH-2

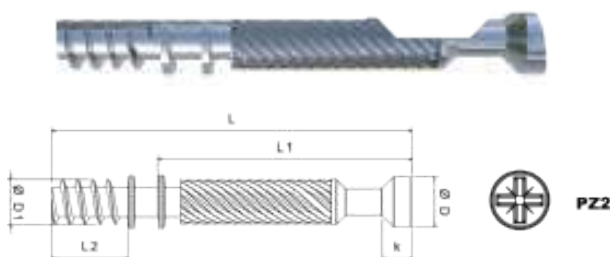

Code	L	L1	L2	k	D	D1	Color	Unit/gr
SH2P34	45	34	11	4	6,6	6,2	Zinc	5,85
SH2P28	39	28	11	4	6,6	6,2	Zinc	4,75
SH2P24	35	24	11	4	6,6	6,2	Zinc	4,3

UNS-79075 Minifix Mili SH-1
UNS-79075 Minifix Bolts SH-1

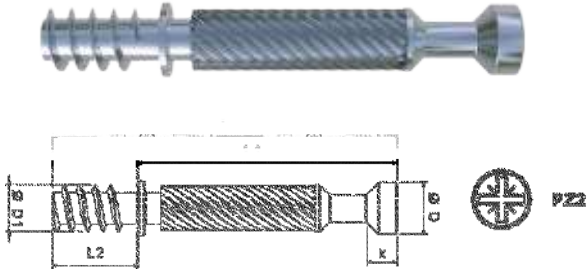

Code	L	L1	L2	k	D	D1	Color	Unit/gr
SH1P34	44,5	30	11	4	6,6	6,2	Zinc	5,85
SH1P28	42,5	28	11	4	6,6	6,2	Zinc	4,75
SH1P24	38,5	24	11	4	6,6	6,2	Zinc	4,3

UNS-79076 Minifix Mili S-5
UNS-79076 Minifix Bolts S-5

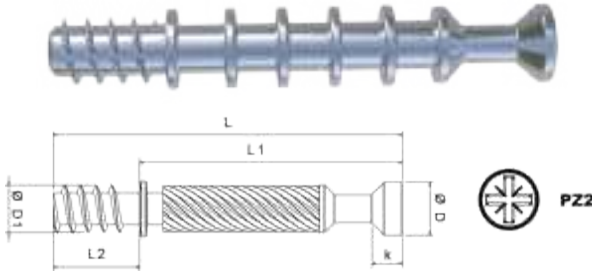

Code	L	L1	L2	k	D	D1	Color	Unit/gr
S5P34	45	34	11	4	6,6	6,2	Zinc	5,85
S5P28	39	28	11	4	6,6	6,2	Zinc	4,75
S5P24	35	24	11	4	6,6	6,2	Zinc	4,3

UNS-79077 Boydan Minifix Mili KD-41
UNS-79077 Row Bolts KD-41

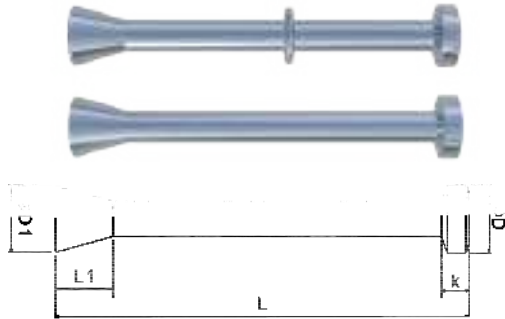

Code	L	L1	k	D	D1	Color	Unit/gr
KD41	41	5	2,5	6	6,1	Zinc	3,6
KDP41	41	5	2,5	6	6,1	Zinc	3,8

UNS-79078 Plastik Dübelli Minifix KD-42
UNS-79078 Row Bolts Set KD-42



Code	D	D1	L	L1	k	Color	Unit/gr
KDT8	6,3	8	42	10	2,5	Zinc	5,85
KDT10	6,3	10	42	10	2,5	Zinc	4,75
KDTP8	6,3	8	42	10	2,5	Zinc	5,85
KDTP10	6,3	10	42	10	2,5	Zinc	4,75

UNS-79079 Kilitli Rafix Vidaları
UNS-79079 Locked Rafix Screws



Code	L	L1	L2	k	D	D1	D2	D3	Coating	Unit/gr
MKRF75	16,5	7,5	9	2,5	6	3,2	7	6	Zinc	3,8
MKRF11	20	11	9	2,5	6	3,2	7	6	Zinc	3,8

UNS-79080 Kilitli Rafix Vidaları (Sunta)
UNS-79080 Locked Rafix Screws (Chipboard)



Code	L	L1	L2	k	D	D1	D2	D3	Color	Unit/gr
SKRF75	16,5	7,5	9	2,5	6	3,2	7	6	Zinc	2,54
SKRF11	20	11	9	2,5	6	3,2	7	6	Zinc	2,85

UNS-79081 Rafix Vidaları
UNS-79081 Rafix Screws (Metric)



Code	L	L1	L2	L3	k	D	D1	D2	Color	Unit/gr
MRF17	17	9,5	7,5	4,5	2,5	9,8	M6	7	Zinc	3,8

UNS-79082 Rafix Vidaları (Sunta)
UNS-79082 Rafix Screws (Chipboard)

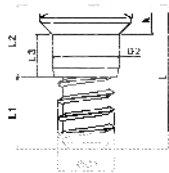

Code	L	L1	L2	L3	k	D	D1	D2	Color	Unit/gr
SRF15	15	7,5	7,5	4,5	2,5	9,8	6,3	7	Zinc	3,2



P22

UNS-81754/14mm Alüminyum Led Profili
UNS-81754/14mm Aluminium Led Profile

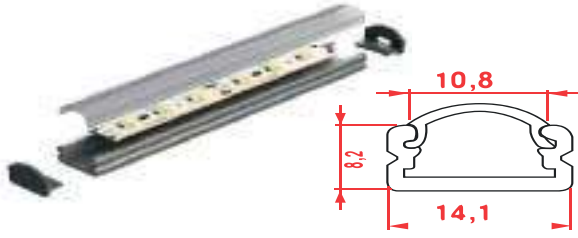

14mm LED Profil
Alm. Alt Kutu
14mm LED Profiles
Alm. Lower Box



14mm LED Profil
PVC Üst Kutu
(Polikarbon)(PVC)
12mm LED Profiles
Top Box (Polycarbonate)(PVC)



12mm LED Bitişler
12mm LED Ends

UNS-81756/16mm Alüminyum Led Profili
UNS-81756/16mm Aluminium Led Profile

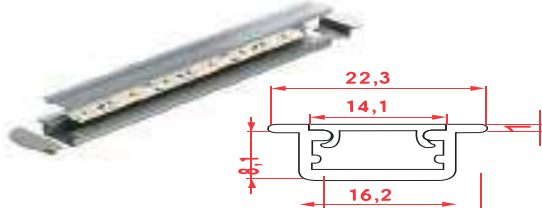

16mm LED Profil
Alm. Alt Kutu
16mm LED Profiles
Alm. Lower Box



16mm LED Profil
PVC Üst Kutu
(Polikarbon)(PVC)
16mm LED Profiles
Top Box (Polycarbonate)(PVC)



16mm LED Bitişler
16mm LED Ends

UNS-81671/7cm Alüminyum Menfez
UNS-81671/7cm Aluminium Grilles

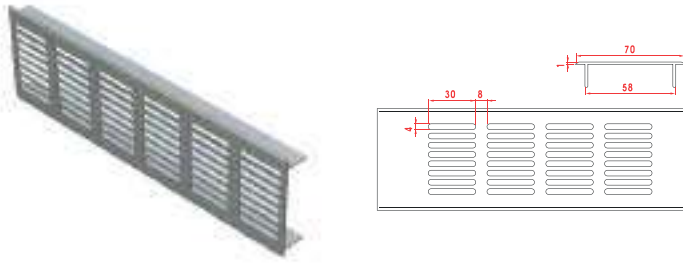

UNS-81672/12cm Alüminyum Menfez
UNS-81672/12cm Aluminium Grilles

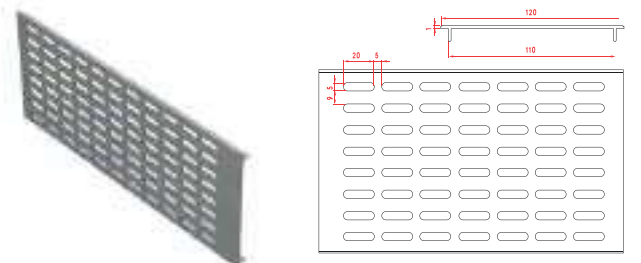

UNS-81011 Ahşap Kapı Fitili
UNS-81011 Wooden Door Gasket



Description	Package-Box
Wooden Door Gasket	100-600

UNS-81012 Ahşap Kapı Fitili
UNS-81012 Wooden Door Gasket



Description	Package-Box
Wooden Door Gasket	100-600

UNS-81013 Ahşap Kapı Fitili
UNS-81013 Wooden Door Gasket



Description	Package-Box
Wooden Door Gasket	100-600

UNS-81014 Ahşap Kapı Fitili
UNS-81014 Wooden Door Gasket

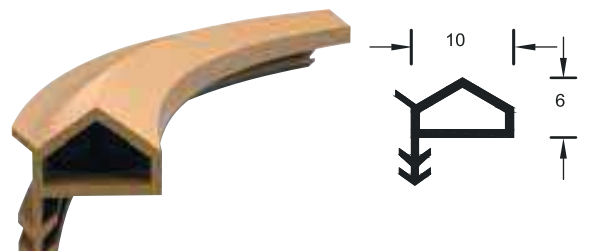

Description	Package-Box
Wooden Door Gasket	100-600

UNS-81025 Ahşap Kapı Fiteli
UNS-81025 Wooden Door Gasket

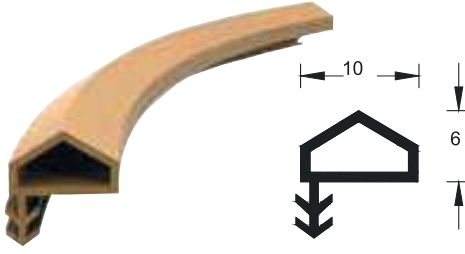

Description	Package-Box
Wooden Door Gasket	100-600

UNS-81039 Ahşap Kapı Fiteli
UNS-81039 Wooden Door Gasket

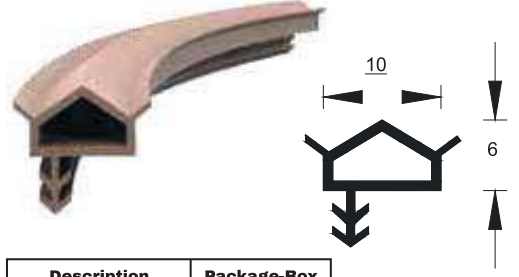

Description	Package-Box
Wooden Door Gasket	100-600

UNS-84001 Coex Kapı Fiteli
UNS-84001 Coex Door Gasket



Description	Package-Box
Coex Door Gasket	100 mt

UNS-84011 Coex Kapı Fiteli
UNS-84011 Coex Door Gasket



Description	Package-Box
Coex Door Gasket	100 mt

UNS-84013 Coex Kapı Fiteli
UNS-84013 Coex Door Gasket



Description	Package-Box
Coex Door Gasket	100 mt

UNS-84036 Coex Kapı Fiteli
UNS-84036 Coex Door Gasket



Description	Package-Box
Coex Door Gasket	100 mt

UNS-82011 Cam Fiteli
UNS-82011 Glass Gasket



Description	Package-Box
Glass Gasket	200 mt

UNS-82015 Cam Fiteli
UNS-82015 Glass Gasket

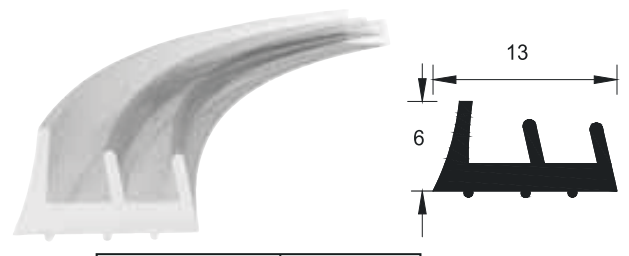

Description	Package-Box
Glass Gasket	200 mt

UNS-82032 Çarpma Fiteli
UNS-82032 Bumper Gasket



Description	Package-Box
Bumper Gasket	200 mt

UNS-82033 Çarpma Fiteli
UNS-82033 Bumper Gasket



Description	Package-Box
Bumper Gasket	200 mt



UNIS BUSINESS

Your Global Solution Partner

“Siz Düşünün Biz Gerçekleştirelim” Unis Business

Unis Danışmanlık

- Unis İhracat ve İthalat Yönetimi A dan Z ye
 - Satış
 - Üretim
- Tedarik Zinciri
- Lojistik

Unis Plastik

- Plastik Enjeksiyon Kalıp
- Plastik Ekstrüzyon

Unis Medya

- Katolog Tasarımı
- Grafik Tasarım

“You Think, We Make It Happen” Unis Business

Unis Consultancy

- Unis Export and Import Management from A to Z
 - Sales
 - Produce
- Supply Chain
- Logistics

Unis Plastic

- Plastic Injection Molding
- Plastic Extrusion Line

Unis Media

- Catalog Design
- Graphic Design



UNIS BUSINESS

Your Global Solution Partner

KOŞULLAR/CONDITIONS

Ünis Ltd. Şti. önceden bildirimde bulunmaksızın ürünlerde her türlü değişiklik yapma hakkını saklı tutar.

Siparişinizi girmeden önce fiyatların ve ürünlerin geçerliliğini teyit etmek için lütfen bizimle iletişime geçin.

Lütfen siparişlerinizi yazılı olarak e-mail ya da whasapp, viber vb. aracılığıyla gönderiniz aksi taktirde siparişiniz kabul edilmeyecektir.

En son fiyat listesi bir öncekini geçersiz kılar.

Tüm hakları Saklıdır.

Unis Ltd. Co. reserves the right to make any modification in products without prior notification.

Please contact us to confirm the validity of prices and products before entering your order.

Please send your orders in writing by e-mail or whasapp, viber etc. otherwise your order will not be accepted.

The latest price list overrides the previous price list.

All rights reserved.

ÜNİS MOBİLYA İÇ ve DIŞ TİCARET LTD. ŞTİ.
UNIS FURNITURE DOMESTIC AND FOREING TRADE LTD. CO.

Sosyal Medya
Social Media



İletişim
Contact



UNIS BUSINESS

YOUR GLOBAL SOLUTION PARTNER
KÜRESEL ÇÖZÜM ORTAĞINIZ



+90 216 434 UNIS

+90 546 434 8647

GENEL MERKEZ/HEAD OFFICE

Beylikbağı Mh. Vatan Cd. No:24/3
Gebze-Kocaeli / TÜRKİYE

İHRACAT OFİS/EXPORT OFFICE

Kaynarca Mh. Gündoğan Sk. No:14/B
Pendik-İstanbul / TÜRKİYE

FABRİKA/FACTORY

Orta Mh. Nilay Sk. Fidan Sanayi No:1/6
Tuzla-İstanbul / TÜRKİYE

info@unisbusiness.com
export@unisbusiness.com

@ www.unisbusiness.com